

FIRE RESISTANCE FOR SERVICE PENETRATIONS

















TEST REPORT



rothoblaas

Solutions for Building Technology

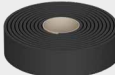
SERVICE PENETRATIONS

PRODUCT	DESCRIPTION		
MASS	INTUMESCENT BRICK FOR MECHANICAL AND ELECTRICAL TECHNICAL PENETRATIONS		
UNICOLLUM	ROLL OF FIRESTOP RING FOR MECHANICAL AND ELECTRICAL TECHNICAL PENETRATIONS		
COLLUM	FIRESTOP RING FOR MECHANICAL AND ELECTRICAL TECHNICAL PENETRATIONS		
SACCUS	FIREPROOF BAG FOR CABLE TRAY PENETRATIONS		
PANNUS	FIREPROOF COVER FOR METAL PIPE PENETRATIONS		
PANEL	PANEL WITH FIREPROOF COATING		
SEAL W	FIREPROOF ACRYLIC SEALANT		
FIRE STRIPE GRAPHITE PRO	FIRE CUFF FOR INSULATED METAL PIPES AND ELECTRICAL CABLES		
GRAPHIT FOAM	TWO-COMPONENT FIREPROOF POLYURETHANE FOAM SUPPLEMENTED WITH GRAPHITE		



FIRE RESISTANCE FOR SERVICE PENETRATIONS ON CLT WALLS AND FLOORS

The following tests were carried out on CLT walls and floors penetrated by various types of pipes, cables, and service penetrations.

The tests were conducted in accordance with EN 1366-3 "Fire resistance tests for service installations – Part 3: Penetration seals", which defines the test methods and criteria for evaluating the ability of a penetration sealing system to maintain the fire resistance of a separating element at the point where it is penetrated by a service installation.

PROPERTY OF THE MATERIAL

CLT		
Wood species [type]	Fir	
Denisty [kg/m ³]	350-420	
Reaction to fire class	D-s2,d0	
Number of layers [no.]	5	
TYPE OF ELEMENT		
	WALL	FLOOR SLAB
Thickness (mm)	137	158



TESTED PRODUCTS

MASS

INTUMESCENT BRICK FOR MECHANICAL AND ELECTRICAL TECHNICAL PENETRATIONS

UNICOLLUM

ROLL OF FIRESTOP COLLAR FOR MECHANICAL AND ELECTRICAL TECHNICAL PENETRATIONS

COLLUM

FIRESTOP COLLAR FOR MECHANICAL AND ELECTRICAL TECHNICAL PENETRATIONS

SACCUS

FIREPROOF BAG FOR CABLE TRAY PENETRATIONS

PANNUS

FIREPROOF COVER FOR METAL PIPE PENETRATIONS

PANEL

SELF-EXPANDING SEALING TAPE

SEAL W

FIREPROOF ACRYLIC SEALANT

FIRE STRIPE GRAPHITE PRO

FIREPROOF TAPE FOR INSULATED METAL PIPES AND ELECTRICAL CABLES

GRAPHIT FOAM

TWO-COMPONENT FIREPROOF POLYURETHANE FOAM SUPPLEMENTED WITH GRAPHITE

TYPE OF PENETRATION



PIPELINES						CABLES		
combustible	insulated combustible	insulated multilayer	bundled multilayer	insulated steel	non-insulated steel	insulated copper	inside combustible pipes	cable trays

PERFORMANCE CRITERIA

The criteria for assessing the performance of the test specimen are detailed in EN 1363-1: 2020. The performance of the test specimen is measured by the time, expressed in minutes, in which the specimen continues to meet the performance criteria described below.

TIGHTNESS

The time in full minutes during which the specimen continues to maintain its separation function without:

- causing a cotton swab to ignite
- allowing the penetration of a feeler gauge
- developing persistent flames









INSULATION

The time in full minutes during which the specimen continues to maintain its separation function, without developing temperatures on the surface not exposed to fire that exceed the initial average temperature at all sensor positions (including the moving thermocouple) by 180°C.

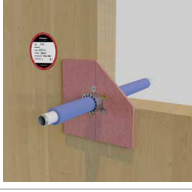
Note: increments refer to the average initial temperature measured on the side not exposed to fire of the test specimen.

SUMMARY TABLE

PENETRATIONS ON CLT WALL WITH A MINIMUM THICKNESS OF 137 mm

	type of penetration system	type of hole	tested products		
PIPELINES	combustible	calibrated	COLLUM UNICOLLUM	page 09	
		oversized	COLLUM UNICOLLUM PANEL SEAL W	page 10	
	insulated combustible	calibrated	COLLUM UNICOLLUM	page 11	
		calibrated	COLLUM UNICOLLUM	page 12	
	insulated multilayer	oversized	GRAPHIT FOAM	page 13	
		oversized	MASS	page 14	
	insulated steel	calibrated	COLLUM UNICOLLUM	page 15	
		oversized	MASS	page 17	
		oversized	COLLUM UNICOLLUM PANEL SEAL W	page 17	
		oversized	FIRE STRIPE GRAPHITE PRO PANEL SEAL W	page 18	
	steel	calibrated	PANNUS	page 19	
		oversized	PANNUS MASS	page 20	
oversized		PANNUS PANEL SEAL W	page 21		
insulated copper	oversized	MASS	page 22		
	oversized	GRAPHIT FOAM	page 23		
	oversized	FIRE STRIPE GRAPHITE PRO PANEL SEAL W	page 24		
CABLES	inside the pipes combustible	calibrated	COLLUM UNICOLLUM	page 25	
		oversized	COLLUM UNICOLLUM PANEL SEAL W	page 26	
		oversized	GRAPHIT FOAM	page 27	
		oversized	FIRE STRIPE GRAPHITE PRO PANEL SEAL W	page 28	
	cable trays	oversized	MASS	page 29	
		oversized	SACCUS SEAL W PANEL SEAL W	page 30	
		oversized	GRAPHIT FOAM	page 31	

SUMMARY TABLE

PENETRATIONS ON CLT FLOOR WITH A MINIMUM THICKNESS OF 158 mm



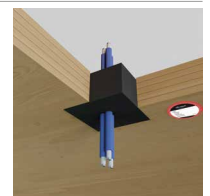

	type of penetration system	type of hole	tested products	
PIPELINES	combustible	calibrated	COLLUM UNICOLLUM	page 32
		oversized	COLLUM UNICOLLUM PANEL SEAL W	page 33
	insulated combustible	calibrated	COLLUM UNICOLLUM	page 34
		insulated multilayer	calibrated	COLLUM UNICOLLUM
	oversized		FIRE STRIPE GRAPHITE PRO PANEL SEAL W	page 36
	oversized		GRAPHIT FOAM	page 37
	bundled multilayer	oversized	MASS	page 38
		insulated steel	calibrated	COLLUM UNICOLLUM
	oversized		MASS	page 40
	oversized		FIRE STRIPE GRAPHITE PRO PANEL SEAL W	page 41
steel	calibrated	PANNUS	page 42	
	oversized	PANNUS MASS	page 43	
	oversized	PANNUS PANEL SEAL W	page 44	
CABLES	inside the pipes combustible	calibrated	COLLUM UNICOLLUM	page 45
		oversized	COLLUM UNICOLLUM PANEL SEAL W	page 46
		oversized	GRAPHIT FOAM	page 47
		oversized	FIRE STRIPE GRAPHITE PRO PANEL SEAL W	page 48
	cable trays	oversized	MASS	page 49
		oversized	SACCUS SEAL W PANEL SEAL W	page 50
		oversized	GRAPHIT FOAM	page 51



PENETRATIONS ON COUNTER WALLS AND FALSE CEILINGS

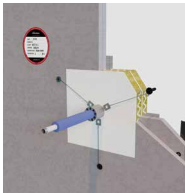

In some cases, fire resistance is provided by the cladding materials. Our passive protection products for penetrations have also been tested on other types of support (rigid and flexible walls, rigid and flexible floors, etc.). Below are just a few examples, consult the ETAs (European Technical Assessments) of our products or contact the technical department for all tested solutions.

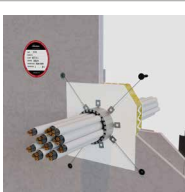
COUNTER WALL PENETRATIONS

	type of penetration system	type of hole	tested products		
PIPELINES	combustible	calibrated	COLLUM UNICOLLUM	page 52	
	insulated multilayer	oversized	COLLUM UNICOLLUM PANEL SEAL W	page 53	
	insulated steel	calibrated	COLLUM UNICOLLUM	page 54	
	steel	calibrated	PANNUS	page 55	
	insulated copper	oversized	FIRE STRIPE GRAPHITE PRO PANEL SEAL W	page 56	
CABLES	inside combustible pipes	oversized	COLLUM UNICOLLUM PANEL SEAL W	page 57	

SUMMARY TABLE

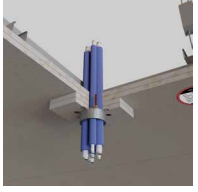
PENETRATIONS ON FALSE CEILING

	type of penetration system	type of hole	tested products		
PIPELINES	combustible	calibrated	COLLUM UNICOLLUM	page 58	
		oversized	COLLUM UNICOLLUM PANEL SEAL W	page 59	
	bundled multilayer	calibrated	COLLUM UNICOLLUM	page 60	
	steel	calibrated	COLLUM UNICOLLUM	page 61	
		calibrated	PANNUS	page 62	
	CABLES	inside combustible pipes	calibrated	FIRE STRIPE GRAPHITE PRO	page 63

PENETRATIONv137 | 1 - TEST REPORT

CALIBRATED HOLE PENETRATION ON CLT WALL WITH COMBUSTIBLE PIPE AND COLLUM OR UNICOLLUM

UNEXPOSED SIDE	no product	
EXPOSED SIDE	COLLUM	UNICOLLUM
Description	Fireproof collar	Fireproof collar in roll
Material	Stainless steel metal strip + intumescent sheath	Stainless steel metal strip + intumescent sheath
Reference ETA	ETA 24/1204	ETA 24/1203

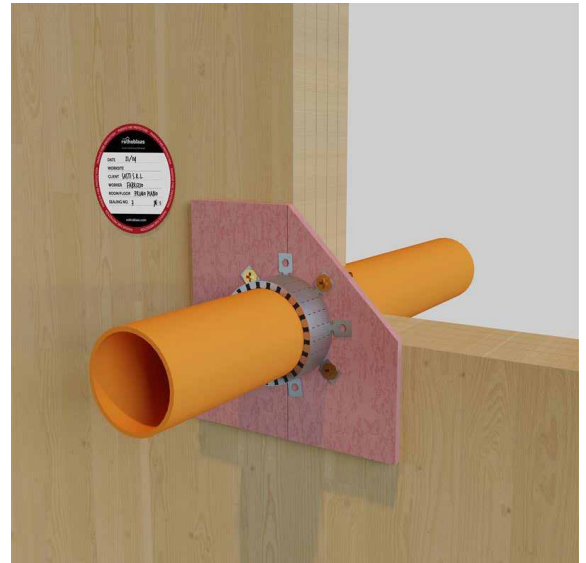
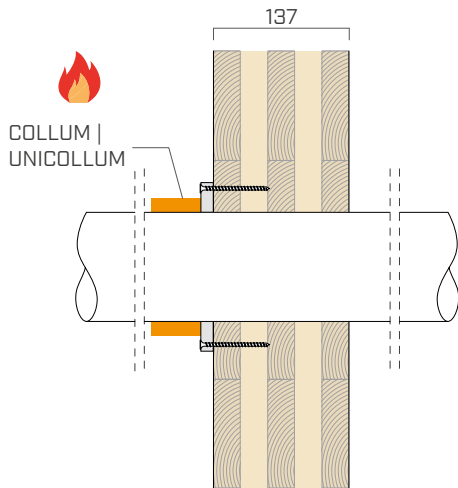

PENETRATION

TYPES	Combustible pipes
PIPE DIAMETER	≤ 110 mm
PIPE INSULATION	Without insulation
HOLE DIMENSION	Equal to the pipe diameter

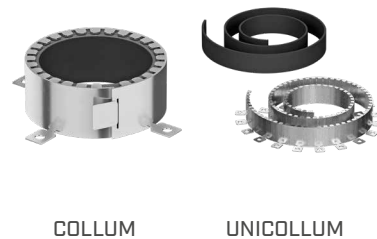

PERFORMANCE CRITERIA

COLLUM or **UNICOLLUM** applied only on the side exposed to fire

TYPE OF PENETRATION SYSTEM	DIAMETER [mm]	PIPE WALL THICKNESS [mm]	
HDPE, PE, ABS, SAN + PVC	≤ 110	3,0 - 4,2	
PP	≤ 110	2,7 - 3,4	
PVC	≤ 110	3,2 - 8,1	

Reference standard: EN 1363-1| EN 1366-3

INSTALLATION

- Create a 12,5 mm thick F-type plasterboard frame (single sheet) on the side exposed to fire
- Install **COLLUM** or **UNICOLLUM** in accordance with the technical data sheet
- Fasten **COLLUM** or **UNICOLLUM** to the plasterboard frame using self-tapping screws.

PENETRATION v 137 | 2 - TEST REPORT

OVERSIZED HOLE PENETRATION ON CLT WALL WITH COMBUSTIBLE PIPE AND COLLUM OR UNICOLLUM + PANEL

UNEXPOSED SIDE	no product	
EXPOSED SIDE	COLLUM	UNICOLLUM
Description	Fireproof collar	Fireproof collar in roll
Material	Stainless steel metal strip + intumescent sheath	Stainless steel metal strip + intumescent sheath
Reference ETA	ETA 24/1204	ETA 24/1203
INFILL	PANEL	SEAL W
Description	Panel with fireproof coating	Fireproof acrylic sealant
Material	Rock wool with ablative treatment	Acrylic polymers
Reference ETA	ETA 24/1206	ETA 24/1207

complementary product for sealing

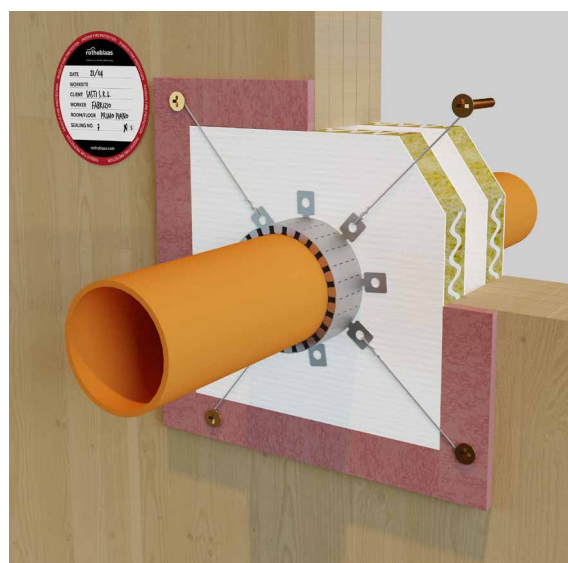
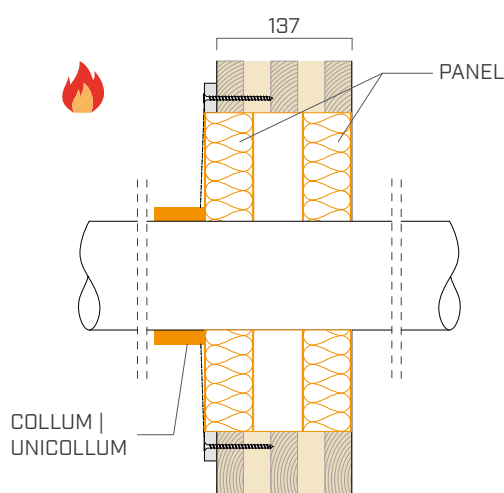

PENETRATION

TYPES	Combustible pipes
PIPE DIAMETER	≤ 110 mm
PIPE INSULATION	Without insulation
HOLE DIMENSION	≤ 600 x 600 mm

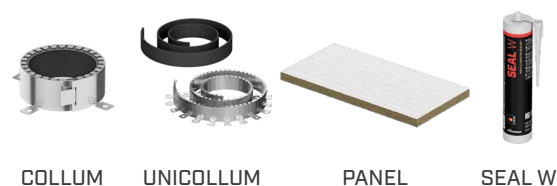

PERFORMANCE CRITERIA

COLLUM or **UNICOLLUM** applied only on the side exposed to fire

TYPE OF PENETRATION SYSTEM	DIAMETER	PIPE WALL THICKNESS	
	[mm]	[mm]	
HDPE, PE, ABS, SAN + PVC	≤ 110	3,0 - 4,2	
PP	≤ 110	2,7 - 3,4	
PVC	≤ 110	3,2 - 8,1	

Reference standard: EN 1363-1| EN 1366-3

INSTALLATION

- Create a 12.5 mm thick F-type plasterboard frame (single sheet) on the side exposed to fire
- Fill the perimeter gap of the pipe with double-layer **PANEL** and seal with **SEAL W**
- Install **COLLUM** or **UNICOLLUM** in accordance with the technical data sheet
- Fasten **COLLUM** or **UNICOLLUM** to the plasterboard frame using wire and self-tapping screws.

PENETRATION v137 | 3 - TEST REPORT

CALIBRATED HOLE PENETRATION ON CLT WALL WITH INSULATED COMBUSTIBLE PIPE AND COLLUM OR UNICOLLUM

UNEXPOSED SIDE	no product	
EXPOSED SIDE	COLLUM	UNICOLLUM
Description	Fireproof collar	Fireproof collar in roll
Material	Stainless steel metal strip + intumescent sheath	Stainless steel metal strip + intumescent sheath
Reference ETA	ETA 24/1204	ETA 24/1203

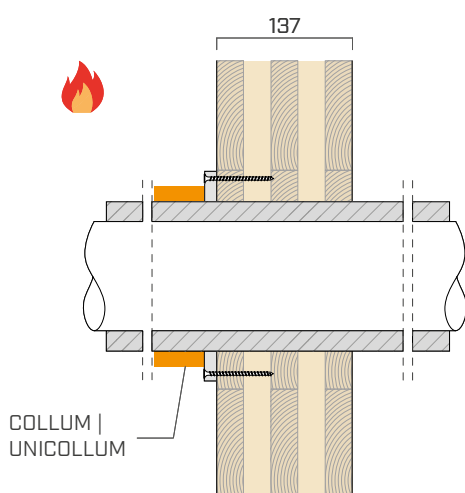

PENETRATION

TYPES	Insulated combustible line
PIPE DIAMETER	≤ 63 mm
PIPE INSULATION	≤ 21,5 mm
HOLE DIMENSION	Equal to the pipe diameter

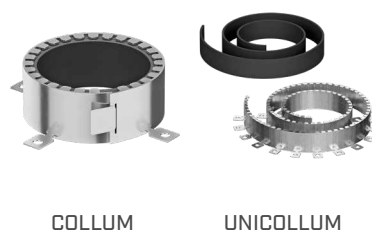

PERFORMANCE CRITERIA

COLLUM or **UNICOLLUM** applied only on the side exposed to fire

TYPE OF PENETRATION SYSTEM	DIAMETER [mm]	PIPE WALL THICKNESS [mm]	INSULATION THICKNESS [mm]	
PPR	≤ 63	10,5	≤ 21,5	

Reference standard: EN 1363-1 | EN 1366-3

INSTALLATION

- Create a 12.5 mm thick F-type plasterboard frame (single sheet) on the side exposed to fire
- Install **COLLUM** or **UNICOLLUM** in accordance with the technical data sheet
- Fasten **COLLUM** or **UNICOLLUM** to the plasterboard frame using self-tapping screws.

PENETRATION v137 | 4 - TEST REPORT

CALIBRATED HOLE PENETRATION ON CLT WALL WITH MULTI-LAYER INSULATED PIPE AND COLLUM OR UNICOLLUM

UNEXPOSED SIDE	no product	
EXPOSED SIDE	COLLUM	UNICOLLUM
Description	Fireproof collar	Fireproof collar in roll
Material	Stainless steel metal strip + intumescent sheath	Stainless steel metal strip + intumescent sheath
Reference ETA	ETA 24/1204	ETA 24/1203

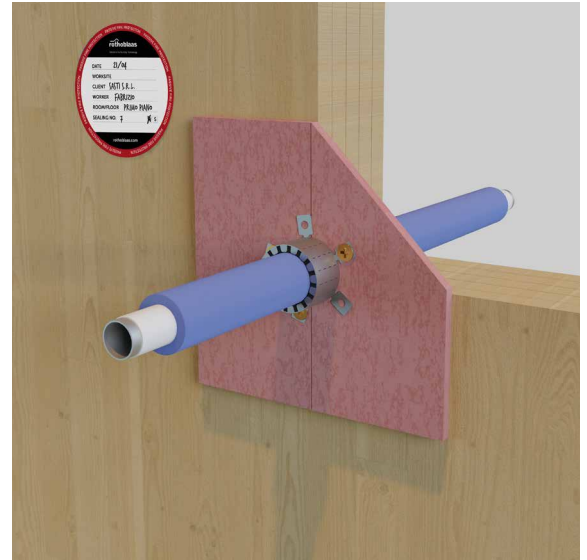
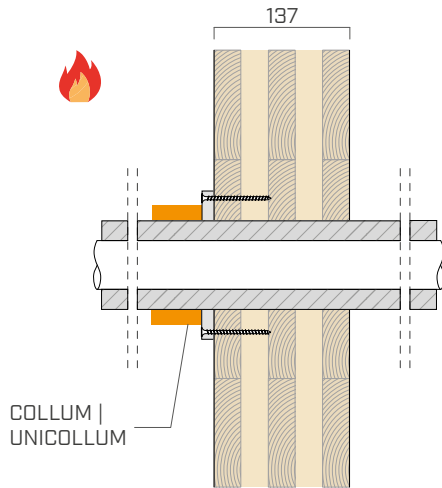

PENETRATION

TYPES	Multilayer insulated combustible line
PIPE DIAMETER	≤ 26 mm
PIPE INSULATION	≤ 8,5 mm
HOLE DIMENSION	Equal to the pipe diameter

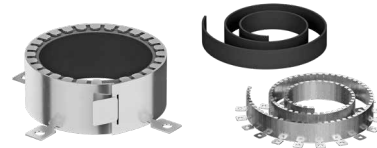

COLLUM

UNICOLLUM

PERFORMANCE CRITERIA

COLLUM or UNICOLLUM applied only on the side exposed to fire

TYPE OF PENETRATION SYSTEM	DIAMETER	PIPE WALL THICKNESS	INSULATION THICKNESS	
	[mm]	[mm]	[mm]	
PE-X/Al/PE-X	≤ 26	3,0	8,5	

Reference standard: EN 1363-1| EN 1366-3

INSTALLATION

- Create a 12.5 mm thick F-type plasterboard frame (single sheet) on the side exposed to fire
- Install **COLLUM** or **UNICOLLUM** in accordance with the technical data sheet
- Fasten **COLLUM** or **UNICOLLUM** to the plasterboard frame using wire and self-tapping screws.

PENETRATION v137 | 5 - TEST REPORT

OVERSIZED HOLE PENETRATION ON CLT WALL WITH MULTI-LAYER PIPES IN BUNDLES AND GRAPHIT FOAM

UNEXPOSED SIDE	no product
EXPOSED SIDE	no product
INFILL	GRAPHIT FOAM
Description	Expanded polyurethane foam
Material	Two-component foam with graphite additive

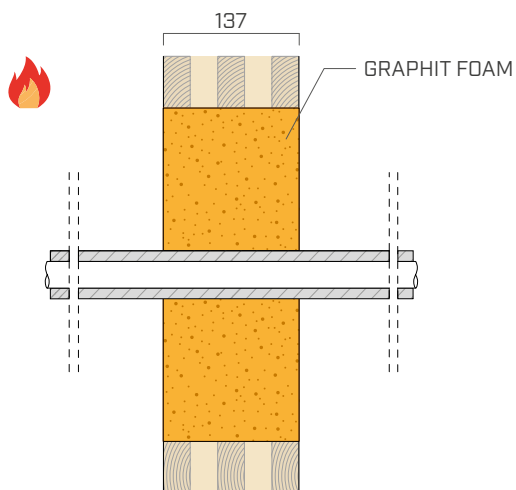

PENETRATION

TYPES	Insulated multilayer pipes
PIPE DIAMETER	≤ 16 mm
PIPE INSULATION	≤ 8 mm
NUMBER OF PIPELINES	2
HOLE DIMENSION	≤ 200 x 200 mm



PERFORMANCE CRITERIA

TYPE OF PENETRATION SYSTEM	DIAMETER [mm]	PIPE WALL THICKNESS [mm]	INSULATION THICKNESS [mm]	
2 PE-Xc/Al0.4/PE-RT	≤ 16	2,0	8,0	

Reference standard: EN 1363-1 | EN 1366-3

INSTALLATION

- Apply **GRAPHIT FOAM** starting from the furthest point, do not interrupt the extrusion to avoid hardening of the material in the mixer. Do not immerse the nozzle in the extruded product
- Wait for the product to fully expand.

PENETRATION v137 | 6 - TEST REPORT

OVERSIZED HOLE PENETRATION ON CLT WALL WITH MULTI-LAYER PIPES IN BUNDLES AND MASS

UNEXPOSED SIDE	no product
EXPOSED SIDE	no product
INFILL	MASS
Description	Intumescent brick
Material	Intumescent polyurethane sponge
Reference ETA	ETA 24/1205

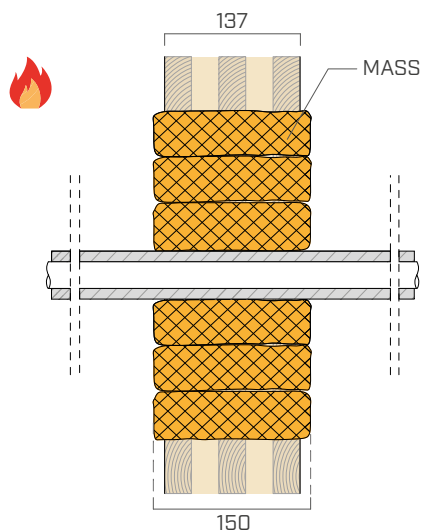

PENETRATION

TYPES	Bundled multilayer pipes
PIPE DIAMETER	≤ 16 mm
PIPE INSULATION	≤ 8 mm
NUMBER OF PIPELINES	2
HOLE DIMENSION	≤ 700 x 300 mm



MASS

PERFORMANCE CRITERIA

TYPE OF PENETRATION SYSTEM	DIAMETER [mm]	PIPE WALL THICKNESS [mm]	INSULATION THICKNESS [mm]	
2 PE-Xc/Al0.4/PE-RT	≤ 16	2,0	8,0	

Reference standard: EN 1363-1| EN 1366-3

INSTALLATION

- Fill the perimeter gap of the pipe by applying suitably shaped **MASS** with the 150 mm side inside the wall. Allow **MASS** to protrude in the case of thin walls.

PENETRATION v137 | 7 - TEST REPORT

CALIBRATED HOLE PENETRATION ON CLT WALL WITH INSULATED STEEL PIPE AND COLLUM OR UNICOLLUM

UNEXPOSED SIDE	no product	
EXPOSED SIDE	COLLUM	UNICOLLUM
Description	Fireproof collar	Fireproof collar in roll
Material	Stainless steel metal strip + intumescent sheath	Stainless steel metal strip + intumescent sheath
Reference ETA	ETA 24/1204	ETA 24/1203

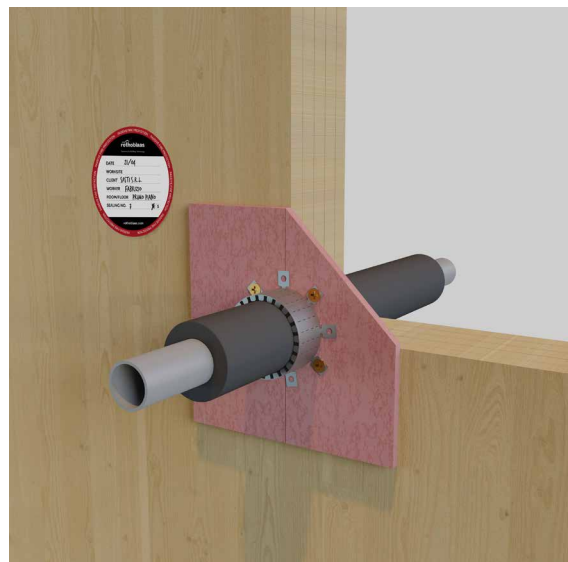
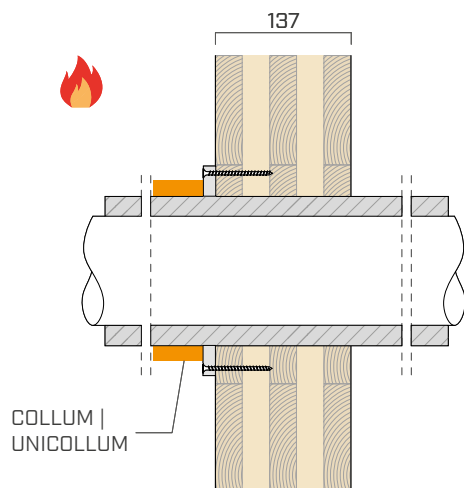

PENETRATION

TYPES	Insulated steel pipework
PIPE DIAMETER	≤ 50 mm
PIPE INSULATION	≤ 21 mm
HOLE DIMENSION	Equal to the pipe diameter

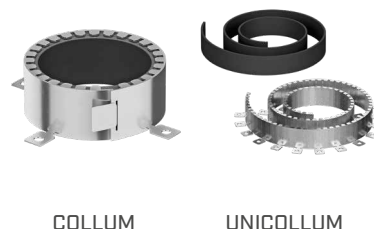

PERFORMANCE CRITERIA

COLLUM or UNICOLLUM applied only on the side exposed to fire

DIAMETER	PIPE WALL THICKNESS	INSULATION THICKNESS	
[mm]	[mm]	[mm]	
≤ 50	≥ 1,5	21,0	

Reference standard: EN 1363-1| EN 1366-3

INSTALLATION

- Create a 12.5 mm thick F-type plasterboard frame (single sheet) on the side exposed to fire
- Install **COLLUM** or **UNICOLLUM** in accordance with the technical data sheet
- Fasten **COLLUM** or **UNICOLLUM** to the plasterboard frame using self-tapping screws.

PENETRATION v137 | 8 - TEST REPORT

OVERSIZED HOLE PENETRATION ON CLT WALL WITH INSULATED STEEL PIPE AND MASS

UNEXPOSED SIDE	no product
EXPOSED SIDE	no product
INFILL	MASS
Description	Intumescent brick
Material	Intumescent polyurethane sponge
Reference ETA	ETA 24/1205

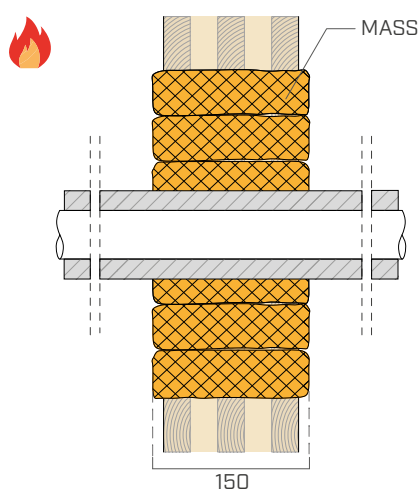

PENETRATION

TYPES	Insulated steel pipework
PIPE DIAMETER	≤ 50 mm
PIPE INSULATION	≤ 21 mm
HOLE DIMENSION	≤ 700 x 300 mm



MASS

PERFORMANCE CRITERIA

DIAMETER	PIPE WALL THICKNESS	INSULATION THICKNESS	
[mm]	[mm]	[mm]	
≤ 50	≥ 1,5	21,0	

Reference standard: EN 1363-1| EN 1366-3

INSTALLATION

- Fill the perimeter gap of the pipe by applying suitably shaped **MASS** with the 150 mm side inside the wall. Allow **MASS** to protrude in the case of thin walls.

PENETRATION v137 | 9 - TEST REPORT

OVERSIZED HOLE PENETRATION ON CLT WALL WITH INSULATED STEEL PIPE AND COLLUM OR UNICOLLUM + PANEL

UNEXPOSED SIDE	no product	
EXPOSED SIDE	COLLUM	UNICOLLUM
Description	Fireproof collar	Fireproof collar in roll
Material	Stainless steel metal strip + intumescent sheath	Stainless steel metal strip + intumescent sheath
Reference ETA	ETA 24/1204	ETA 24/1203
INFILL	PANEL	SEAL W
Description	Panel with fireproof coating	Fireproof acrylic sealant
Material	Rock wool with ablative treatment	Acrylic polymers
Reference ETA	ETA 24/1206	ETA 24/1207

or
complementary product for sealing

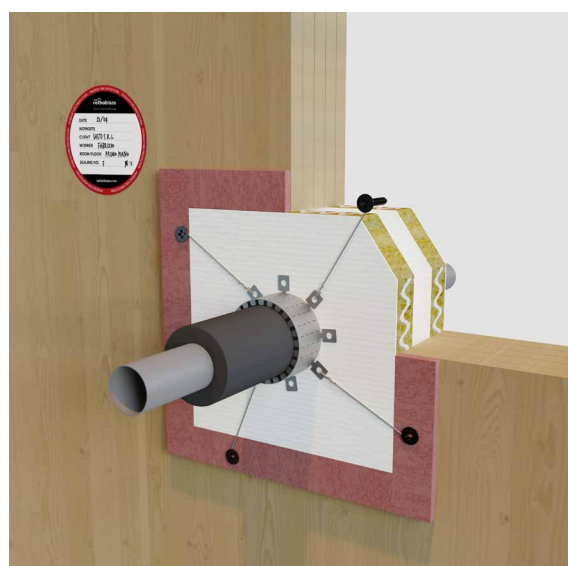
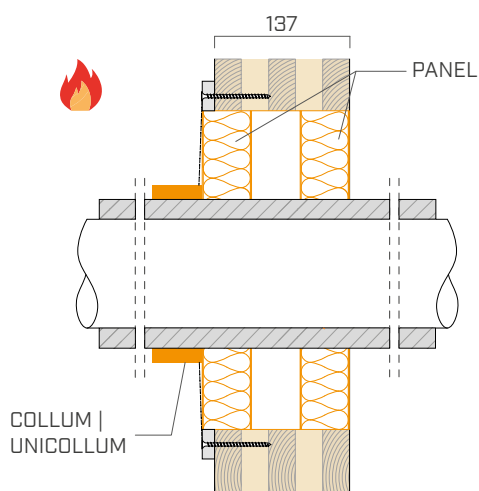

PENETRATION

TYPES	Insulated steel pipework
PIPE DIAMETER	≤ 50 mm
PIPE INSULATION	≤ 21 mm
HOLE DIMENSION	≤ 600 x 600 mm

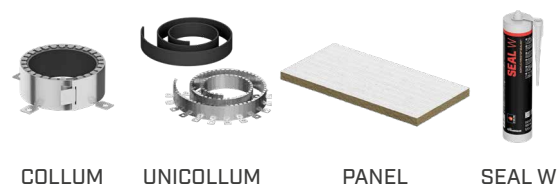

PERFORMANCE CRITERIA

COLLUM or **UNICOLLUM** applied only on the side exposed to fire

DIAMETER	PIPE WALL THICKNESS	INSULATION THICKNESS	
[mm]	[mm]	[mm]	
≤ 50	≥ 1,5	21,0	

Reference standard: EN 1363-1 | EN 1366-3

INSTALLATION

- Create a 12.5 mm thick F-type plasterboard frame (single sheet) on the side exposed to fire
- Fill the perimeter gap of the pipe with double-layer **PANEL** and seal with **SEAL W**
- Install **COLLUM** or **UNICOLLUM** in accordance with the technical data sheet
- Fasten **COLLUM** or **UNICOLLUM** to the plasterboard frame using wire and self-tapping screws.

PENETRATION v137 | 10 - TEST REPORT

OVERSIZED HOLE PENETRATION ON CLT WALL WITH INSULATED STEEL PIPE AND FIRE STRIPE GRAPHITE PRO + PANEL

UNEXPOSED SIDE	no product	
EXPOSED SIDE	FIRE STRIPE GRAPHITE PRO	
Description	Fireproof tape	
Material	Intumescent sheath 4 mm thick	
INFILL	PANEL	SEAL W
Description	Panel with fireproof coating	Fireproof acrylic sealant
Material	Rock wool with ablative treatment	Acrylic polymers
Reference ETA	ETA 24/1206	ETA 24/1207

complementary product for sealing

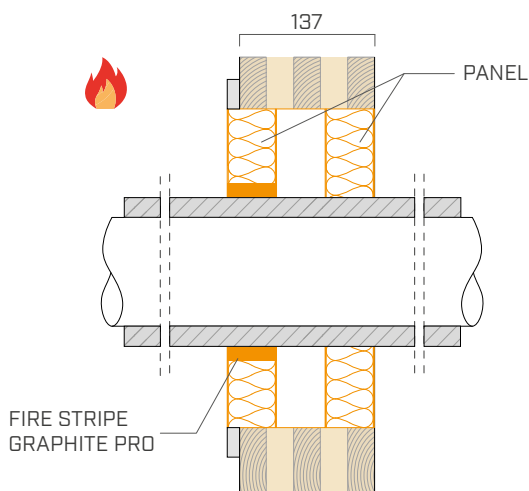

PENETRATION

TYPES	Insulated steel pipework
PIPE DIAMETER	≤ 50 mm
PIPE INSULATION	≤ 21 mm
HOLE DIMENSION	≤ 600 x 600 mm

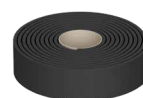

FIRE STRIPE GRAPHITE PRO



PANEL



SEAL W

PERFORMANCE CRITERIA

FIRE STRIPE GRAPHITE PRO applied only on the side exposed to fire

DIAMETER	PIPE WALL THICKNESS	INSULATION THICKNESS	
[mm]	[mm]	[mm]	
≤ 50	≥ 1,5	21,0	

Reference standard: EN 1363-1| EN 1366-3

INSTALLATION

- Create a 12.5 mm thick F-type plasterboard frame (single sheet) on the side exposed to fire
- Wrap **FIRE STRIPE GRAPHITE PRO** around the pipe
- Fasten **FIRE STRIPE GRAPHITE PRO** with adhesive tape and position it at the penetration on the fire side
- Fill the perimeter gap with double-layer **PANEL** and seal with **SEAL W**.

PENETRATION v137 | 11 - TEST REPORT

CALIBRATED HOLE PENETRATION ON CLT WALL WITH STEEL PIPE AND PANNUS

UNEXPOSED SIDE	PANNUS
Description	Fireproof covering for metal pipes
Material	Incombustible mineral wool fabric and ablative cooling treatment
EXPOSED SIDE	no product

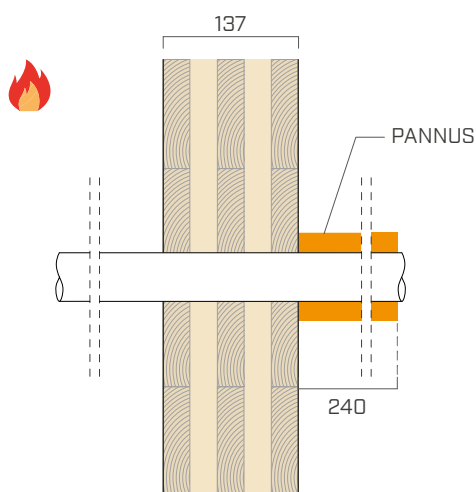

PENETRATION

TYPES	Steel pipe
PIPE DIAMETER	≤ 50 mm
PIPE INSULATION	Without insulation
HOLE DIMENSION	Equal to the pipe diameter



PANNUS

PERFORMANCE CRITERIA

PANNUS applied only on the side not exposed to fire

PIPE DIAMETER	PIPE WALL THICKNESS	NUMBER OF WINDINGS	
[mm]	[mm]	[mm]	
≤ 50	≥ 1,5	2 x 240	

Reference standard: EN 1363-1| EN 1366-3

INSTALLATION

- Wrap the pipe with two layers of **PANNUS** adhering to the side not exposed to fire
- Fasten **PANNUS** with a wire coil.

PENETRATION v137 | 12 - TEST REPORT

OVERSIZED HOLE PENETRATION ON CLT WALL WITH STEEL PIPE AND PANNUS + MASS

UNEXPOSED SIDE	PANNUS
Description	Fireproof covering for metal pipes
Material	Incombustible mineral wool fabric and ablative cooling treatment
EXPOSED SIDE	no product
INFILL	MASS
Description	Intumescent brick
Material	Intumescent polyurethane sponge
Reference ETA	ETA 24/1205

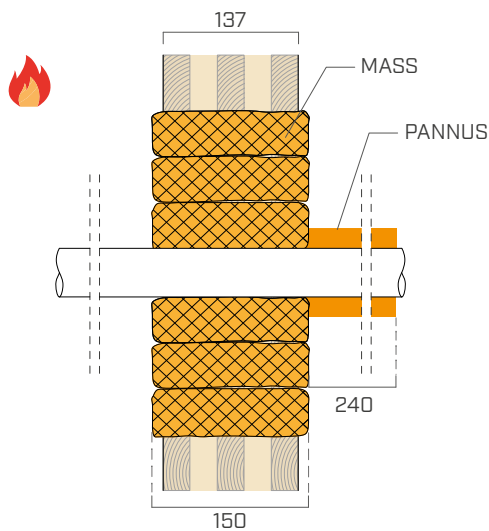

PENETRATION

TYPES	Steel pipe
PIPE DIAMETER	≤ 50 mm
PIPE INSULATION	Without insulation
HOLE DIMENSION	≤ 700 x 300 mm



PANNUS



MASS

PERFORMANCE CRITERIA

PANNUS applied only on the side not exposed to fire

PIPE DIAMETER	PIPE WALL THICKNESS	NUMBER OF WINDINGS	
[mm]	[mm]	[mm]	
≤ 50	≥ 1,5	2 x 240	

Reference standard: EN 1363-1| EN 1366-3

INSTALLATION

- Fill the perimeter gap of the pipe by applying suitably shaped **MASS**
- Wrap the pipe with two layers of **PANNUS** adhering to the side not exposed to fire
- Fasten **PANNUS** with a wire coil.

PENETRATIONv137 | 13 - TEST REPORT

OVERSIZED HOLE PENETRATION ON CLT WALL WITH STEEL PIPE AND PANNUS + PANEL

UNEXPOSED SIDE	PANNUS	
Description	Fireproof covering for metal pipes	
Material	Incombustible mineral wool fabric and ablative cooling treatment	
EXPOSED SIDE	no product	
INFILL	PANEL	SEAL W
Description	Panel with fireproof coating	Fireproof acrylic sealant
Material	Rock wool with ablative treatment	Acrylic polymers
Reference ETA	ETA 24/1206	ETA 24/1207

complementary product for sealing

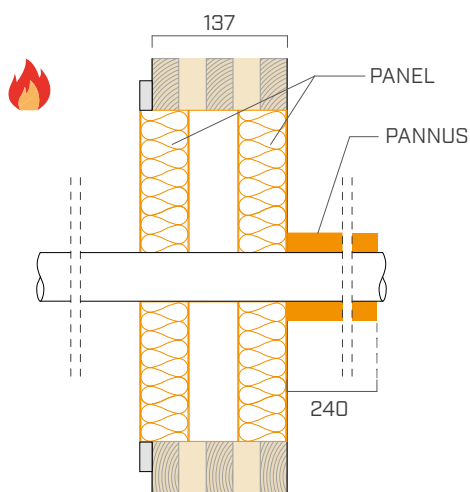

PENETRATION

TYPES	Steel pipe
PIPE DIAMETER	≤ 50 mm
PIPE INSULATION	Without insulation
HOLE DIMENSION	≤ 600 x 600 mm



PANEL

SEAL W

PANNUS

PERFORMANCE CRITERIA

PANNUS applied only on the side not exposed to fire

PIPE DIAMETER	PIPE WALL THICKNESS	NUMBER OF WINDINGS	
[mm]	[mm]	[mm]	
≤ 50	≥ 1,5	2 x 240	

Reference standard: EN 1363-1| EN 1366-3

INSTALLATION

- Create a 12.5 mm thick F-type plasterboard frame (single sheet) on the side exposed to fire
- Fill the perimeter gap with double-layer **PANEL** and seal with **SEAL W**
- Wrap the pipe with two layers of **PANNUS** adhering to the side not exposed to fire
- Fasten **PANNUS** with a wire coil.

PENETRATIONv137 | 14 - TEST REPORT

OVERSIZED HOLE PENETRATION ON CLT WALL WITH INSULATED COPPER PIPE AND MASS

UNEXPOSED SIDE	no product
EXPOSED SIDE	no product
INFILL	MASS
Description	Intumescent brick
Material	Intumescent polyurethane sponge
Reference ETA	ETA 24/1205

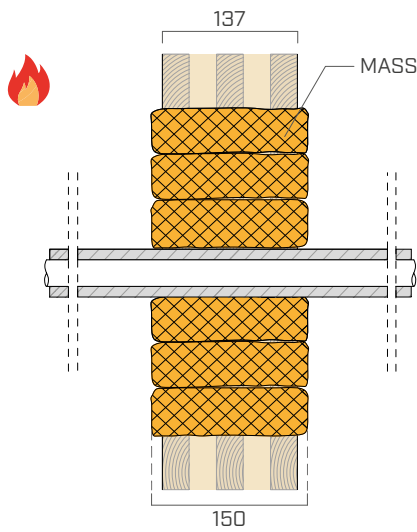

PENETRATION

TYPES	Insulated copper pipes
PIPE DIAMETER	≤ 22 mm
PIPE INSULATION	≤ 8,5 mm
NUMBER OF PIPELINES	2
HOLE DIMENSION	≤ 700 x 300 mm



MASS

PERFORMANCE CRITERIA

PIPE DIAMETER [mm]	PIPE WALL THICKNESS [mm]	INSULATION THICKNESS [mm]	
≤ 22	≥ 1	8,5	

Reference standard: EN 1363-1| EN 1366-3
 (*)EI = tightness and insulation, E = tightness

INSTALLATION

- Fill the perimeter gap of the pipe by applying suitably shaped **MASS** with the 150 mm side inside the wall. Allow **MASS** to protrude in the case of thin walls.

PENETRATION v137 | 15 - TEST REPORT

OVERSIZED HOLE PENETRATION ON CLT WALL WITH INSULATED COPPER PIPE AND GRAPHIT FOAM

UNEXPOSED SIDE	no product
EXPOSED SIDE	no product
INFILL	GRAPHIT FOAM
Description	Expanded polyurethane foam
Material	Two-component foam with graphite additive

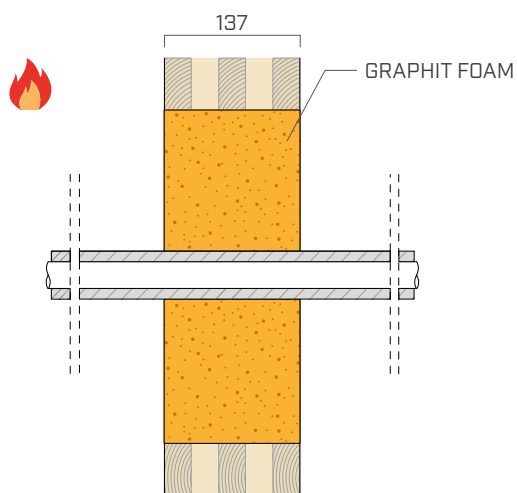

PENETRATION

TYPES	insulated copper pipes
PIPE DIAMETER	≤ 22 mm
PIPE INSULATION	≤ 8,5 mm
NUMBER OF PIPELINES	2
HOLE DIMENSION	≤ 200 x 200 mm



GRAPHIT FOAM

PERFORMANCE CRITERIA

PIPE DIAMETER	PIPE WALL THICKNESS	INSULATION THICKNESS	
[mm]	[mm]	[mm]	
≤ 22	≥ 1	8,5	

Reference standard: EN 1363-1| EN 1366-3

INSTALLATION

- Apply **GRAPHIT FOAM** starting from the furthest point, do not interrupt the extrusion to avoid hardening of the material in the mixer. Do not immerse the nozzle in the extruded product
- Wait for the product to fully expand.

PENETRATION v137 | 16 - TEST REPORT

OVERSIZED HOLE PENETRATION ON CLT WALL WITH INSULATED COPPER PIPE AND FIRE STRIPE GRAPHITE PRO + PANEL

UNEXPOSED SIDE	no product	
EXPOSED SIDE	FIRE STRIPE GRAPHITE PRO	
Description	Fireproof tape	
Material	Intumescent sheath 4 mm thick	
INFILL	PANEL	SEAL W
Description	Panel with fireproof coating	Fireproof acrylic sealant
Material	Rock wool with ablative treatment	Acrylic polymers
Reference ETA	ETA 24/1206	ETA 24/1207

complementary product for sealing

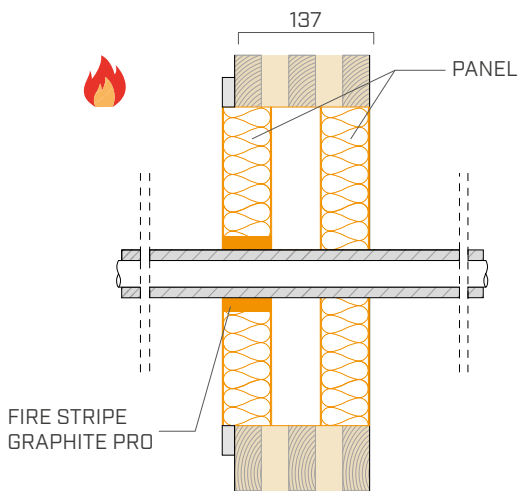

PENETRATION

TYPES	Insulated copper pipes
PIPE DIAMETER	≤ 22 mm
PIPE INSULATION	≤ 8,5 mm
HOLE DIMENSION	≤ 600 x 600 mm

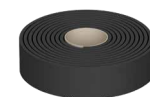

FIRE STRIPE GRAPHITE PRO



PANEL



SEAL W

PERFORMANCE CRITERIA

FIRE STRIPE GRAPHITE PRO applied only on the side exposed to fire

PIPE DIAMETER [mm]	PIPE WALL THICKNESS [mm]	INSULATION THICKNESS [mm]	
≤ 22	≥ 1	8,5	(*)

Reference standard: EN 1363-1| EN 1366-3
(*)EI = tightness and insulation, E = tightness

INSTALLATION

- Create a 12.5 mm thick F-type plasterboard frame (single sheet) on the side exposed to fire
- Wrap FIRE STRIPE GRAPHITE PRO around the pipe
- Fasten FIRE STRIPE GRAPHITE PRO with adhesive tape and position it at the penetration on the fire side
- Fill the perimeter gap with double-layer PANEL and seal with SEAL W.

PENETRATION v137 | 17 - TEST REPORT

CALIBRATED HOLE PENETRATION ON CLT WALL WITH ELECTRICAL CABLES IN COMBUSTIBLE PIPES AND COLLUM OR UNICOLLUM

UNEXPOSED SIDE	no product	
EXPOSED SIDE	COLLUM	UNICOLLUM
Description	Fireproof collar	Fireproof collar in roll
Material	Stainless steel metal strip + intumescent sheath	Stainless steel metal strip + intumescent sheath
Reference ETA	ETA 24/1204	ETA 24/1203

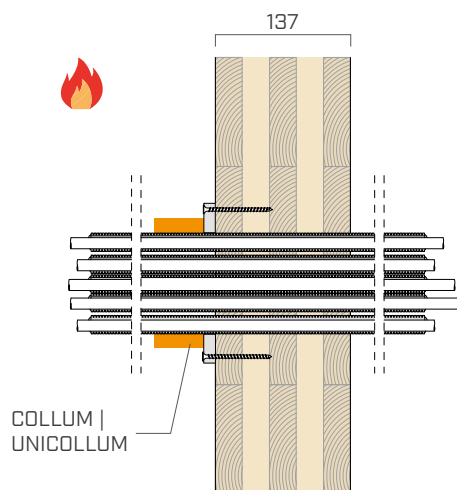

PENETRATION

TYPES	Electrical cables in combustible pipes
PIPE DIAMETER	≤ 82 mm
PIPE INSULATION	≤ 8,5 mm
HOLE DIMENSION	Equal to the pipe diameter

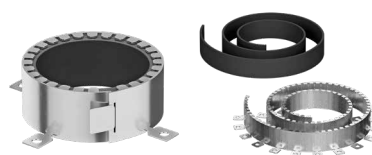

COLLUM

UNICOLLUM

PERFORMANCE CRITERIA

COLLUM or UNICOLLUM applied only on the side exposed to fire

TYPE OF PENETRATION SYSTEM	OVERALL DIAMETER [mm]	PIPE DIAMETER [mm]	PIPE WALL THICKNESS [mm]	INSULATION THICKNESS [mm]	
1 PE-X/Al/PE-X	≤ 65	≤ 26	3,0	8,5	
2 corrugated PVC pipes with A2-type cable		≤ 24	2,0	-	
7 PVC corrugated pipes with A2-type cable	≤ 82	≤ 24	2,0	-	

Reference standard: EN 1363-1| EN 1366-3

INSTALLATION

- Create a 12.5 mm thick F-type plasterboard frame (single sheet) on the side exposed to fire
- Install **COLLUM** or **UNICOLLUM** in accordance with the technical data sheet
- Fasten **COLLUM** or **UNICOLLUM** to the plasterboard frame using self-tapping screws.

PENETRATION v137 | 18 - TEST REPORT

OVERSIZED HOLE PENETRATION ON CLT WALL WITH ELECTRICAL CABLES IN COMBUSTIBLE PIPES AND COLLUM OR UNICOLLUM + PANEL

UNEXPOSED SIDE	no product	
EXPOSED SIDE	COLLUM	UNICOLLUM
Description	Fireproof collar	Fireproof collar in roll
Material	Stainless steel metal strip + intumescent sheath	Stainless steel metal strip + intumescent sheath
INFILL	PANEL	SEAL W
Description	Panel with fireproof coating	Fireproof acrylic sealant
Material	Rock wool with ablative treatment	Acrylic polymers
Reference ETA	ETA 24/1206	ETA 24/1207

complementary product for sealing

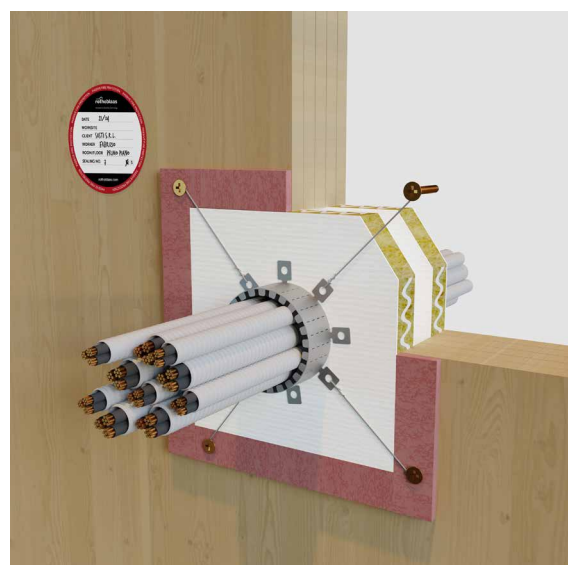
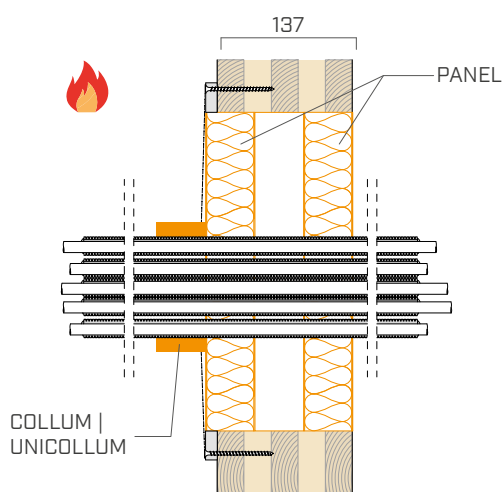

PENETRATION

TYPES	Electrical cables in combustible pipes
PIPE DIAMETER	≤ 82 mm
PIPE INSULATION	≤ 8,5 mm
HOLE DIMENSION	≤ 600 x 600 mm

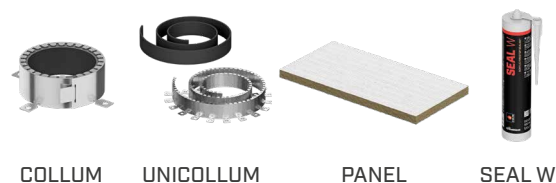

PERFORMANCE CRITERIA

COLLUM or **UNICOLLUM** applied only on the side exposed to fire

TYPE OF PENETRATION SYSTEM	OVERALL DIAMETER [mm]	PIPE DIAMETER [mm]	PIPE WALL THICKNESS [mm]	INSULATION THICKNESS [mm]	
1 PE-X/Al/PE-X	≤ 65	≤ 26	3,0	8,5	
2 corrugated PVC pipes with A2-type cable		≤ 24	2,0	-	
7 PVC corrugated pipes with A2-type cable	≤ 82	≤ 24	2,0	-	

Reference standard: EN 1363-1| EN 1366-3

INSTALLATION

- Create a 12.5 mm thick F-type plasterboard frame (single sheet) on the side exposed to fire
- Fill the perimeter gap of the pipe with double-layer **PANEL** and seal with **SEAL W**
- Install **COLLUM** or **UNICOLLUM** in accordance with the technical data sheet
- Fasten **COLLUM** or **UNICOLLUM** to the plasterboard frame using wire and self-tapping screws.

PENETRATION v137 | 19 - TEST REPORT

OVERSIZED HOLE PENETRATION ON CLT WALL WITH ELECTRICAL CABLES IN COMBUSTIBLE PIPES AND GRAPHIT FOAM

UNEXPOSED SIDE	no product
EXPOSED SIDE	no product
INFILL	GRAPHIT FOAM
Description	Expanded polyurethane foam
Material	Two-component foam with graphite additive

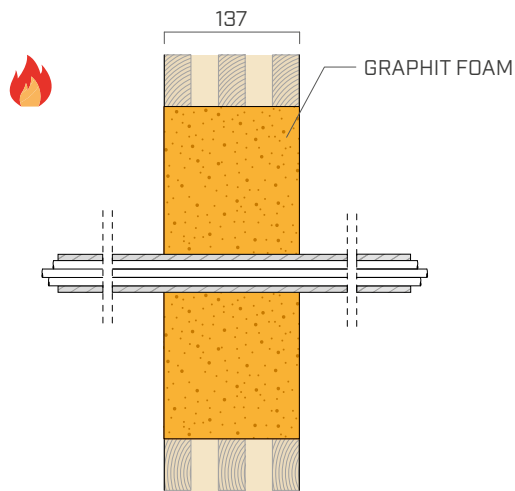

PENETRATION

TYPES	Electrical cables in combustible pipes
PIPE DIAMETER	≤ 24 mm
HOLE DIMENSION	≤ 200 x 200 mm



GRAPHIT FOAM

PERFORMANCE CRITERIA

TYPE OF PENETRATION SYSTEM	PIPE DIAMETER [mm]	PIPE WALL THICKNESS [mm]	INSULATION THICKNESS [mm]	
corrugated PVC pipes with A2-type cable	≤ 24	2,0	-	

Reference standard: EN 1363-1 | EN 1366-3

INSTALLATION

- Apply **GRAPHIT FOAM** starting from the furthest point, do not interrupt the extrusion to avoid hardening of the material in the mixer. Do not immerse the nozzle in the extruded product
- Wait for the product to fully expand.

PENETRATION v137 | 20 - TEST REPORT

OVERSIZED HOLE PENETRATION ON CLT WALL WITH ELECTRICAL CABLES IN COMBUSTIBLE PIPES AND FIRE STRIPE GRAPHITE PRO + PANEL

UNEXPOSED SIDE	no product	
EXPOSED SIDE	FIRE STRIPE GRAPHITE PRO	
Description	Fireproof tape	
Material	Intumescent sheath 4 mm thick	
INFILL	PANEL	SEAL W
Description	Panel with fireproof coating	Fireproof acrylic sealant
Material	Rock wool with ablative treatment	Acrylic polymers
Reference ETA	ETA 24/1206	ETA 24/1207

complementary product for sealing

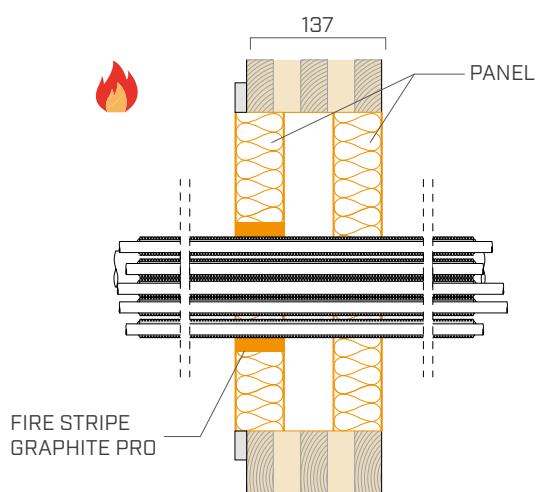

PENETRATION

TYPES	Electrical cables in combustible pipes
PIPE DIAMETER	≤ 82 mm
HOLE DIMENSION	≤ 600 x 600 mm



FIRE STRIPE GRAPHITE PRO

PANEL

SEAL W

PERFORMANCE CRITERIA

FIRE STRIPE GRAPHITE PRO applied only on the side exposed to fire

TYPE OF PENETRATION SYSTEM	OVERALL DIAMETER [mm]	PIPE DIAMETER [mm]	PIPE WALL THICKNESS [mm]	INSULATION THICKNESS [mm]	NUMBER OF WINDINGS [mm]	
1 PE-X/Al/PE-X	≤ 65	≤ 26	3,0	8,5	2 x 50	
2 corrugated PVC pipes with A2-type cable		≤ 24	2,0	-		
7 PVC corrugated pipes with A2-type cable		≤ 82	≤ 24	2,0		

Reference standard: EN 1363-1| EN 1366-3

INSTALLATION

- Create a 12.5 mm thick F-type plasterboard frame (single sheet) on the side exposed to fire
- Wrap two layers of **FIRE STRIPE GRAPHITE PRO** around the pipe
- Fasten **FIRE STRIPE GRAPHITE PRO** with adhesive tape and position it at the penetration on the fire side
- Fill the perimeter gap with double-layer **PANEL** and seal with **SEAL W**.

PENETRATION v137 | 21 - TEST REPORT

OVERSIZED HOLE PENETRATION ON CLT WALL WITH CABLE TRAY AND MASS

UNEXPOSED SIDE	no product
EXPOSED SIDE	no product
INFILL	MASS
Description	Intumescent brick
Material	Intumescent polyurethane sponge
Reference ETA	ETA 24/1205

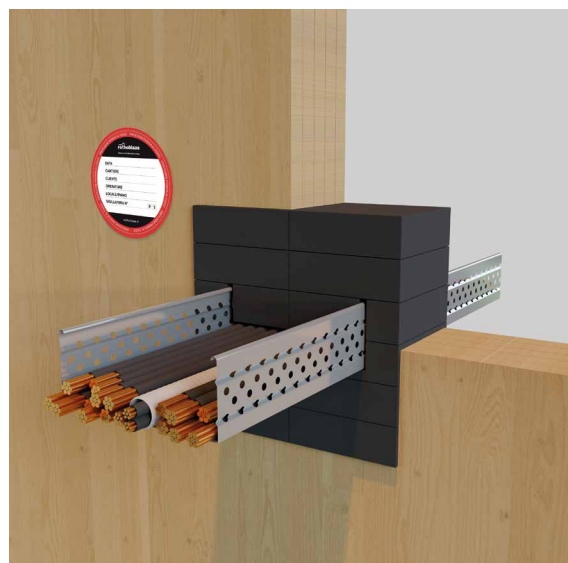
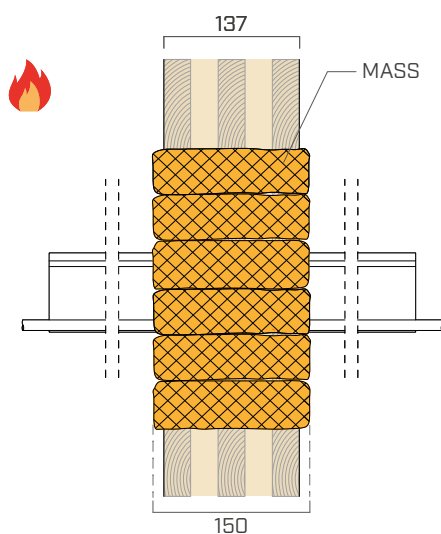

PENETRATION

TYPES	Metal cable tray
CABLE TRAY SIZE	296 x 75 mm
HOLE DIMENSION	≤ 700 x 300 mm



MASS

PERFORMANCE CRITERIA

TYPE OF PENETRATION SYSTEM	DIAMETER [mm]	
10 H07RN-F 5G1.5	≤ 21	
10 FG16OR 16 5G1.5		
10 H05VV-F 5G1.5		
2 FG16R16 1 X 95		
1 corrugated pipe with A2-type cable	≤ 24	

Reference standard: EN 1363-1 | EN 1366-3

(*) EI = tightness and insulation, E = tightness

INSTALLATION

- Fill the gap by applying suitably shaped **MASS** with the 150 mm side inside the wall. Allow **MASS** to protrude in the case of thin walls.

PENETRATION v137 | 22 - TEST REPORT

OVERSIZED HOLE PENETRATION ON CLT WALL WITH CABLE TRAY AND SACCUS + PANEL

UNEXPOSED SIDE	no product	
EXPOSED SIDE	no product	
INFILL	SACCUS	SEAL W
Description	Fireproof bearing	Fireproof acrylic sealant
Material	Fibreglass bag containing intumescent, water-releasing granular compounds	Acrylic polymers
Reference ETA	ETA 24/1082	ETA 24/1207
INFILL	PANEL	SEAL W
Description	Panel with fireproof coating	Fireproof acrylic sealant
Material	Rock wool with ablative treatment	Acrylic polymers
Reference ETA	ETA 24/1206	ETA 24/1207

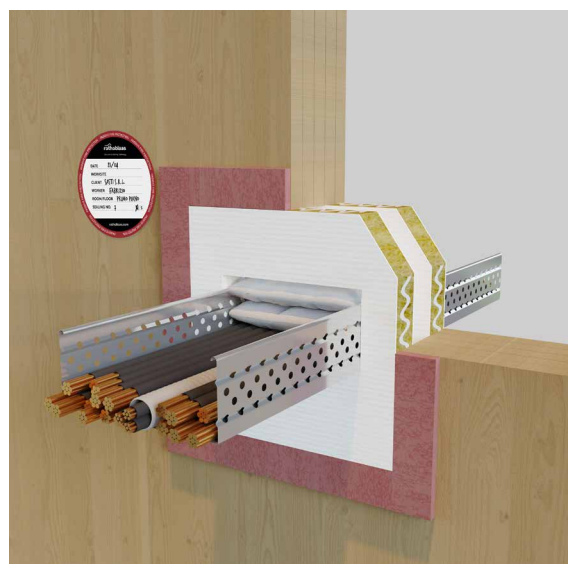
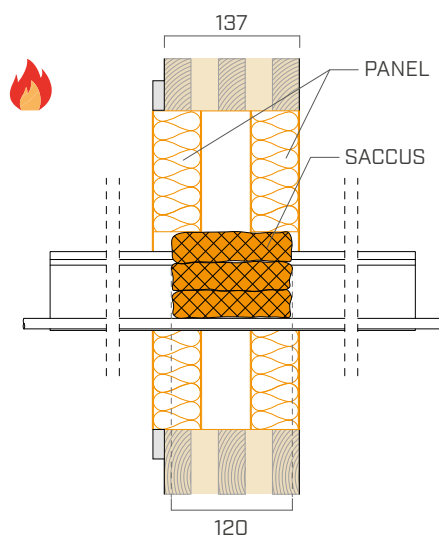

PENETRATION

TYPES	Metal cable tray
CABLE TRAY SIZE	300 x 75 mm
HOLE DIMENSION	≤ 600 x 600 mm

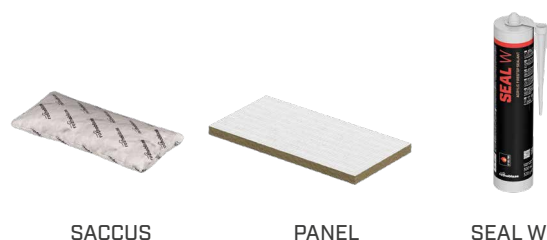

PERFORMANCE CRITERIA

TYPE OF PENETRATION SYSTEM	DIAMETER [mm]	
10 H07RN-F 5G1.5	≤ 21	
10 FG16OR 16 5G1.5		
10 H05VV-F 5G1.5		
2 FG16R16 1 X 95		

Reference standard: EN 1363-1 | EN 1366-3

INSTALLATION

- Create a 12.5 mm thick F-type plasterboard frame (single sheet) on the side exposed to fire
- Fill the gap around the cable tray with **SACCUS** with the 150 mm side inside the wall and seal with **SEAL W**. Allow **SACCUS** to protrude in the case of thin walls
- Fill the perimeter gap with double-layer **PANEL** and seal with **SEAL W**.

PENETRATION v137 | 23 - TEST REPORT

OVERSIZED HOLE PENETRATION ON CLT WALL WITH CABLE TRAY AND GRAPHIT FOAM

UNEXPOSED SIDE	no product
EXPOSED SIDE	no product
INFILL	GRAPHIT FOAM
Description	Expanded polyurethane foam
Material	Two-component foam with graphite additive

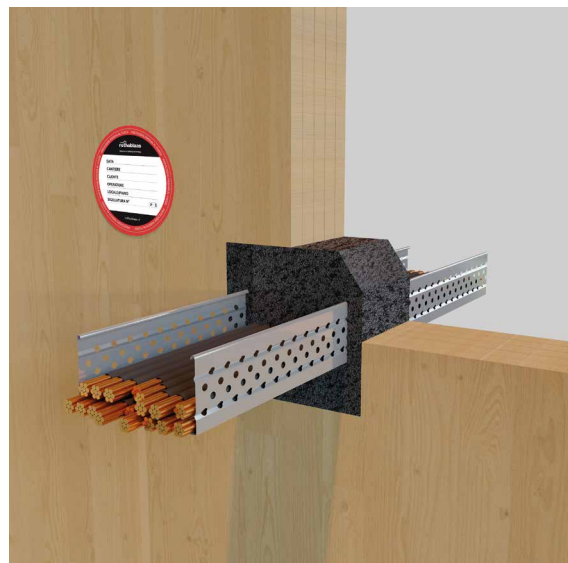
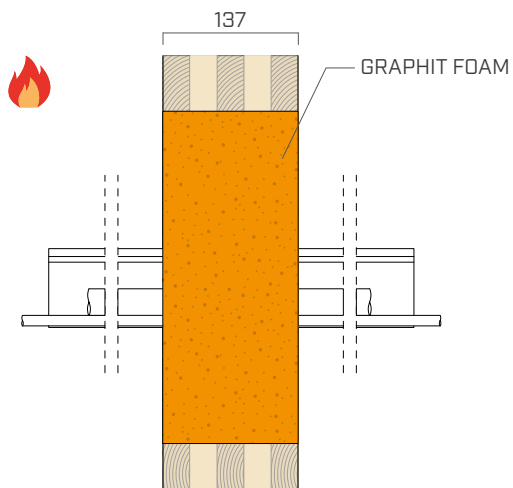

PENETRATION

TYPES	Metal cable tray
CABLE TRAY SIZE	150 x 75 mm
HOLE DIMENSION	≤ 200 x 200 mm



GRAPHIT FOAM

PERFORMANCE CRITERIA

TYPE OF PENETRATION SYSTEM	DIAMETER [mm]	
10 H07RN-F 5G1.5	≤ 21	
10 FG16OR 16 5G1.5		

Reference standard: EN 1363-1| EN 1366-3
 (*)EI = tightness and insulation, E = tightness

INSTALLATION

- Apply **GRAPHIT FOAM** starting from the furthest point, do not interrupt the extrusion to avoid hardening of the material in the mixer. Do not immerse the nozzle in the extruded product
- Wait for the product to fully expand.

PENETRATION h158 | 1 - TEST REPORT

CALIBRATED HOLE PENETRATION ON CLT FLOOR WITH COMBUSTIBLE PIPE AND COLLUM OR UNICOLLUM

UNEXPOSED SIDE	no product	
EXPOSED SIDE	COLLUM	UNICOLLUM
Description	Fireproof collar	Fireproof collar in roll
Material	Stainless steel metal strip + intumescent sheath	Stainless steel metal strip + intumescent sheath
Reference ETA	ETA 24/1204	ETA 24/1203

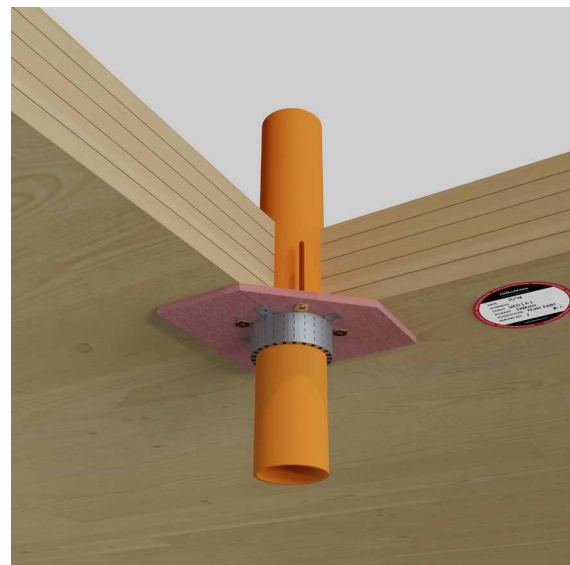
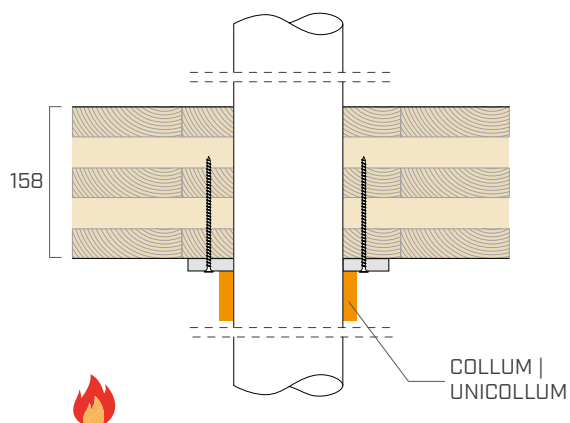

PENETRATION

TYPES	Combustible pipes
PIPE DIAMETER	≤ 110 mm
PIPE INSULATION	Without insulation
HOLE DIMENSION	Equal to the pipe diameter

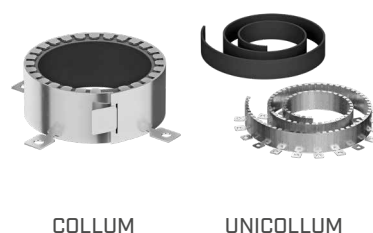

PERFORMANCE CRITERIA

COLLUM or UNICOLLUM applied only on the side exposed to fire

TYPE OF PENETRATION SYSTEM	DIAMETER [mm]	PIPE WALL THICKNESS [mm]	
HDPE, PE, ABS, SAN + PVC	≤ 110	3,0 - 4,2	
PP	≤ 110	2,7 - 3,4	
PVC	≤ 110	3,2 - 8,1	

Reference standard: EN 1363-1 | EN 1366-3

INSTALLATION

- Create a 12.5 mm thick F-type plasterboard frame (single sheet) on the side exposed to fire
- Install **COLLUM** or **UNICOLLUM** in accordance with the technical data sheet
- Fasten **COLLUM** or **UNICOLLUM** to the plasterboard frame using self-tapping screws.

PENETRATION h158 | 2 - TEST REPORT

OVERSIZED HOLE PENETRATION ON CLT FLOOR WITH COMBUSTIBLE PIPE AND COLLUM OR UNICOLLUM + PANEL

UNEXPOSED SIDE	no product	
EXPOSED SIDE	COLLUM	UNICOLLUM
Description	Fireproof collar	Fireproof collar in roll
Material	Stainless steel metal strip + intumescent sheath	Stainless steel metal strip + intumescent sheath
Reference ETA	ETA 24/1204	ETA 24/1203
INFILL	PANEL	SEAL W
Description	Panel with fireproof coating	Fireproof acrylic sealant
Material	Rock wool with ablative treatment	Acrylic polymers
Reference ETA	ETA 24/1206	ETA 24/1207

or
complementary product for sealing

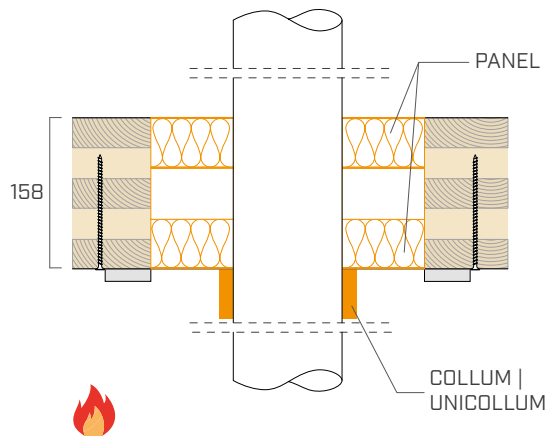

PENETRATION

TYPES	Combustible pipes
PIPE DIAMETER	≤ 110 mm
PIPE INSULATION	Without insulation
HOLE DIMENSION	≤ 700 x 500 mm

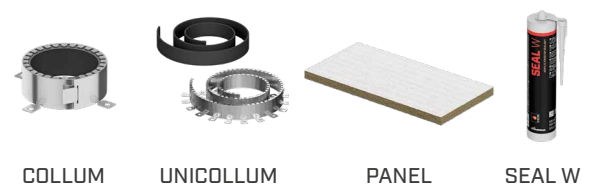

PERFORMANCE CRITERIA

COLLUM or **UNICOLLUM** applied only on the side exposed to fire

TYPE OF PENETRATION SYSTEM	DIAMETER	PIPE WALL THICKNESS	
	[mm]	[mm]	
HDPE, PE, ABS, SAN + PVC	≤ 110	3,0 - 4,2	
PP	≤ 110	2,7 - 3,4	
PVC	≤ 110	3,2 - 8,1	

Reference standard: EN 1363-1 | EN 1366-3

INSTALLATION

- Create a 12.5 mm thick F-type plasterboard frame (single sheet) on the side exposed to fire
- Fill the perimeter gap of the pipe with double-layer **PANEL** and seal with **SEAL W**. If appropriate, create a support mesh for the products
- Install **COLLUM** or **UNICOLLUM** in accordance with the technical data sheet
- Fasten **COLLUM** or **UNICOLLUM** to the plasterboard frame using wire and self-tapping screws.

PENETRATIONh158 | 3 - TEST REPORT

CALIBRATED HOLE PENETRATION ON CLT FLOOR WITH INSULATED COMBUSTIBLE PIPE AND COLLUM OR UNICOLLUM

UNEXPOSED SIDE	no product	
EXPOSED SIDE	COLLUM	UNICOLLUM
Description	Fireproof collar	Fireproof collar in roll
Material	Stainless steel metal strip + intumescent sheath	Stainless steel metal strip + intumescent sheath
Reference ETA	ETA 24/1204	ETA 24/1203

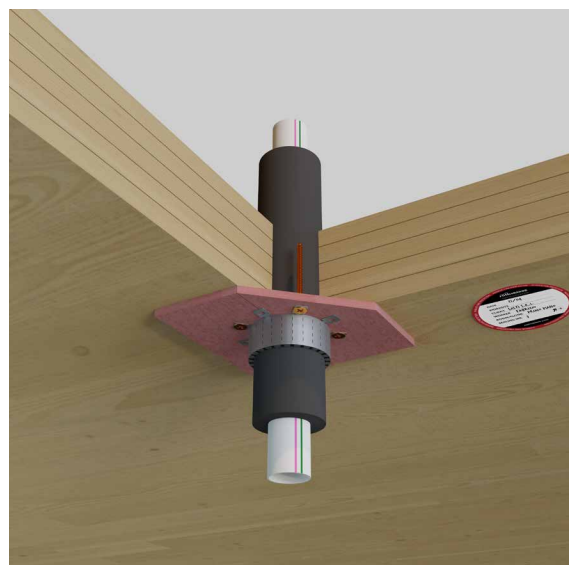
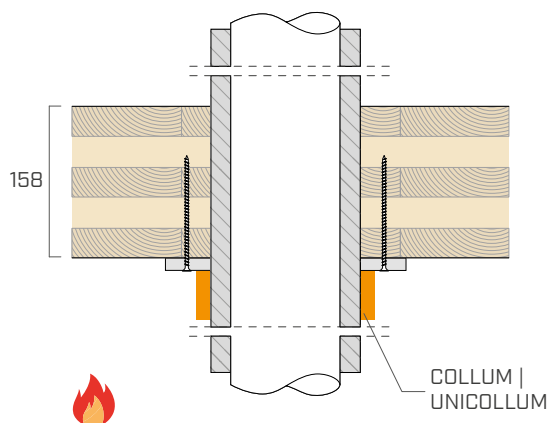

PENETRATION

TYPES	Insulated combustible line
PIPE DIAMETER	≤ 63 mm
PIPE INSULATION	≤ 17 mm
HOLE DIMENSION	Equal to the pipe diameter

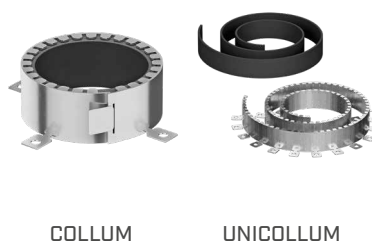

PERFORMANCE CRITERIA

COLLUM or **UNICOLLUM** applied only on the side exposed to fire

TYPE OF PENETRATION SYSTEM	DIAMETER [mm]	PIPE WALL THICKNESS [mm]	INSULATION THICKNESS [mm]	
PPR	≤ 63	10,5	≤ 17	

Reference standard: EN 1363-1| EN 1366-3

INSTALLATION

- Create a 12.5 mm thick F-type plasterboard frame (single sheet) on the side exposed to fire
- Install **COLLUM** or **UNICOLLUM** in accordance with the technical data sheet
- Fasten **COLLUM** or **UNICOLLUM** to the plasterboard frame using self-tapping screws.

PENETRATION h158 | 4 - TEST REPORT

CALIBRATED HOLE PENETRATION ON CLT FLOOR WITH MULTI-LAYER INSULATED PIPE AND COLLUM OR UNICOLLUM

UNEXPOSED SIDE	no product	
EXPOSED SIDE	COLLUM	UNICOLLUM
Description	Fireproof collar	Fireproof collar in roll
Material	Stainless steel metal strip + intumescent sheath	Stainless steel metal strip + intumescent sheath
Reference ETA	ETA 24/1204	ETA 24/1203

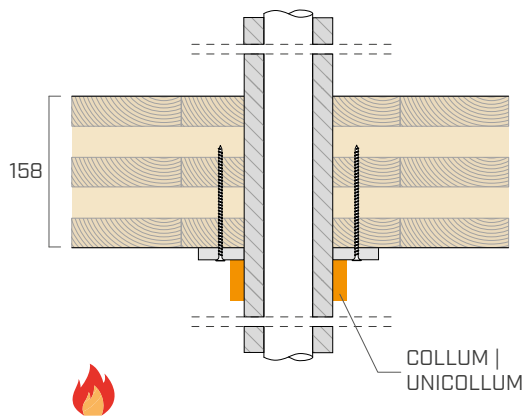

PENETRATION

TYPES	Multilayer insulated combustible line
PIPE DIAMETER	≤ 63 mm
PIPE INSULATION	≤ 17 mm
HOLE DIMENSION	Equal to the pipe diameter

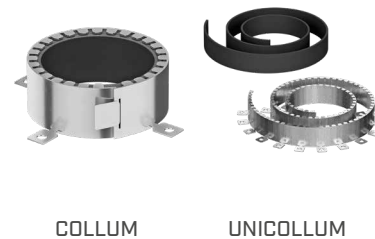

PERFORMANCE CRITERIA

COLLUM or **UNICOLLUM** applied only on the side exposed to fire

TYPE OF PENETRATION SYSTEM	DIAMETER [mm]	PIPE WALL THICKNESS [mm]	INSULATION THICKNESS [mm]	
PE-X/Al/HDPE	≤ 63	6,0	17,0	

Reference standard: EN 1363-1 | EN 1366-3

INSTALLATION

- Create a 12.5 mm thick F-type plasterboard frame (single sheet) on the side exposed to fire
- Install **COLLUM** or **UNICOLLUM** in accordance with the technical data sheet
- Fasten **COLLUM** or **UNICOLLUM** to the plasterboard frame using self-tapping screws.

PENETRATION h158 | 5 - TEST REPORT

OVERSIZED HOLE PENETRATION ON CLT FLOOR WITH MULTI-LAYER PIPE AND FIRE STRIPE GRAPHITE PRO + PANEL

UNEXPOSED SIDE	no product	
EXPOSED SIDE	FIRE STRIPE GRAPHITE PRO	
Description	Fireproof tape	
Material	Intumescent sheath 4 mm thick	
INFILL	PANEL	SEAL W
Description	Panel with fireproof coating	Fireproof acrylic sealant
Material	Rock wool with ablative treatment	Acrylic polymers
Reference ETA	ETA 24/1206	ETA 24/1207

complementary product for sealing

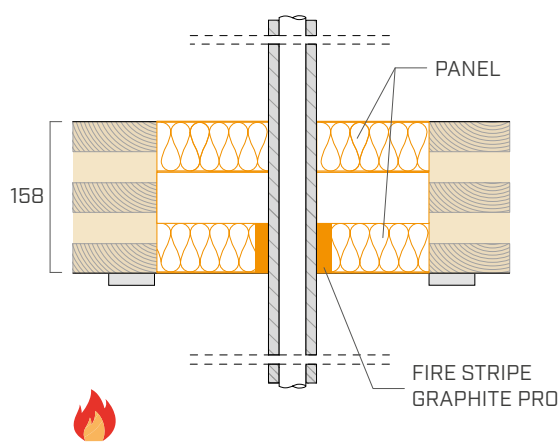

PENETRATION

TYPES	Multilayer insulated combustible line
PIPE DIAMETER	≤ 20 mm
PIPE INSULATION	≤ 8 mm
HOLE DIMENSION	≤ 700 x 500 mm

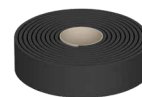

FIRE STRIPE GRAPHITE PRO



PANEL



SEAL W

PERFORMANCE CRITERIA

FIRE STRIPE GRAPHITE PRO applied only on the side exposed to fire

TYPE OF PENETRATION SYSTEM	DIAMETER [mm]	PIPE WALL THICKNESS [mm]	INSULATION THICKNESS [mm]	
PE-XB/AL/PE-HD	20	2,25	8,0	

Reference standard: EN 1363-1| EN 1366-3

INSTALLATION

- Create a 12.5 mm thick F-type plasterboard frame (single sheet) on the side exposed to fire
- Wrap **FIRE STRIPE GRAPHITE PRO** around the pipe
- Fasten **FIRE STRIPE GRAPHITE PRO** with adhesive tape and position it at the penetration on the fire side
- Fill the perimeter gap with two layers of **PANEL** and seal with **SEAL W**. If necessary, create a support mesh for the products.

PENETRATION h158 | 6 - TEST REPORT

OVERSIZED HOLE PENETRATION ON CLT FLOOR WITH MULTI-LAYER PIPES IN BUNDLES AND GRAPHIT FOAM

UNEXPOSED SIDE	no product
EXPOSED SIDE	no product
INFILL	GRAPHIT FOAM
Description	Expanded polyurethane foam
Material	Two-component foam with graphite additive

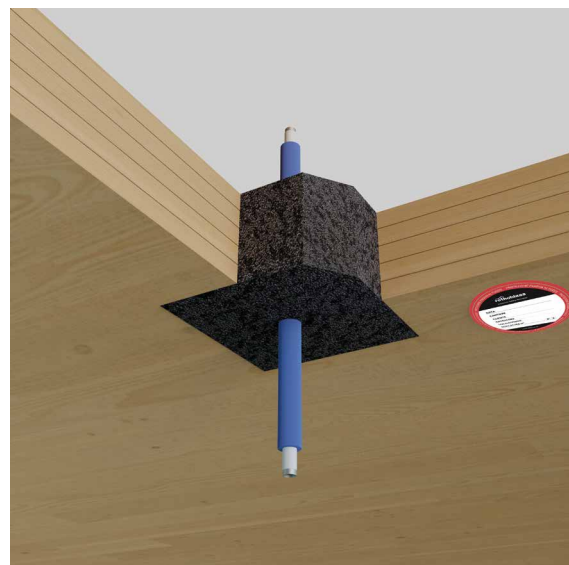
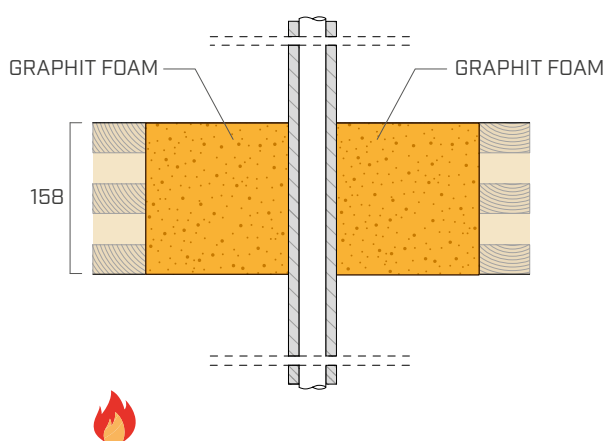

PENETRATION

TYPES	Multilayer insulated combustible line
PIPE DIAMETER	≤ 20 mm
PIPE INSULATION	≤ 8 mm
NUMBER OF PIPELINES	2
HOLE DIMENSION	≤ 300 x 250 mm



GRAPHIT FOAM

PERFORMANCE CRITERIA

TYPE OF PENETRATION SYSTEM	DIAMETER [mm]	PIPE WALL THICKNESS [mm]	INSULATION THICKNESS [mm]	
PE-XB/AL/PE-HD	≤ 20	2,25	8,0	
PE-XB/AL/PE-HD	≤ 16	2,0	8,0	

Reference standard: EN 1363-1 | EN 1366-3

INSTALLATION

- Preparing the support formwork for foam
- Apply **GRAPHIT FOAM** starting from the furthest point, do not interrupt the extrusion to avoid hardening of the material in the mixer. Do not immerse the nozzle in the extruded product
- Wait for the product to fully expand. If appropriate, create a support mesh for the product.

PENETRATION h158 | 7 - TEST REPORT

OVERSIZED HOLE PENETRATION ON CLT FLOOR WITH MULTI-LAYER PIPES IN BUNDLES AND MASS

UNEXPOSED SIDE	no product
EXPOSED SIDE	no product
INFILL	MASS
Description	Intumescent brick
Material	Intumescent polyurethane sponge
Reference ETA	ETA 24/1205

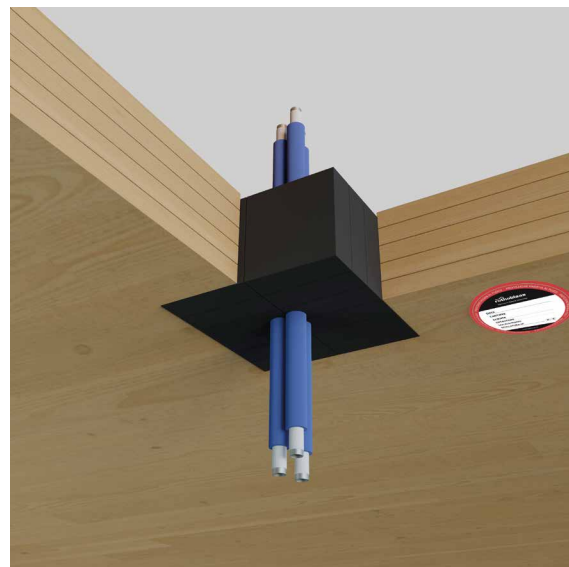
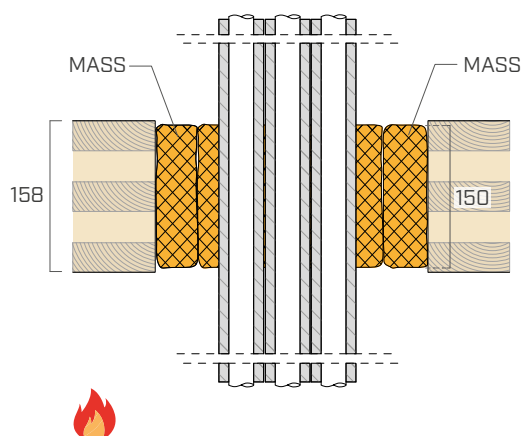

PENETRATION

TYPES	Bundled multilayer pipes
PIPE DIAMETER	≤ 20 mm
PIPE INSULATION	≤ 8 mm
NUMBER OF PIPELINES	3
HOLE DIMENSION	≤ 700 x 300 mm

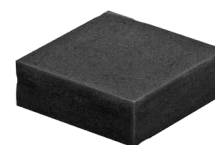

MASS

PERFORMANCE CRITERIA

TYPE OF PENETRATION SYSTEM	DIAMETER [mm]	PIPE WALL THICKNESS [mm]	INSULATION THICKNESS [mm]	
3 PE-XB/AL/PE-HD	≤ 20	2,25	8,0	

Reference standard: EN 1363-1| EN 1366-3

(*) EI = tightness and insulation, E = tightness

INSTALLATION

- Fill the perimeter gap of the pipe by applying suitably shaped **MASS** with the 150 mm side inside the thickness of the floor. If appropriate, create a support mesh for the product.

PENETRATION h158 | 8 - TEST REPORT

CALIBRATED HOLE PENETRATION ON CLT FLOOR WITH INSULATED STEEL PIPE AND COLLUM OR UNICOLLUM

UNEXPOSED SIDE	no product	
EXPOSED SIDE	COLLUM	UNICOLLUM
Description	Fireproof collar	Fireproof collar in roll
Material	Stainless steel metal strip + intumescent sheath	Stainless steel metal strip + intumescent sheath
Reference ETA	ETA 24/1204	ETA 24/1203

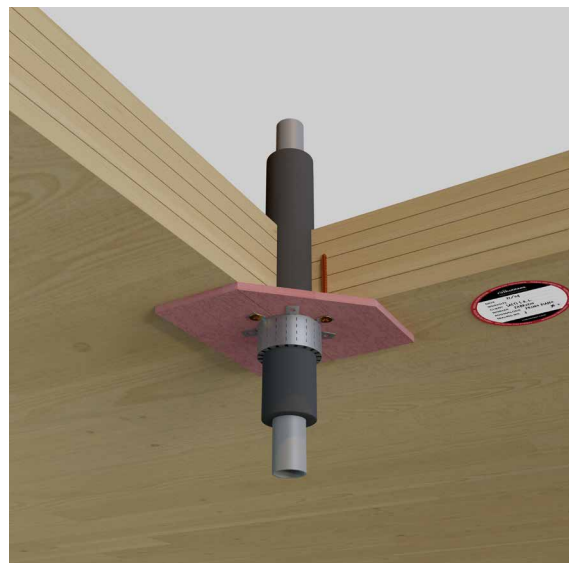
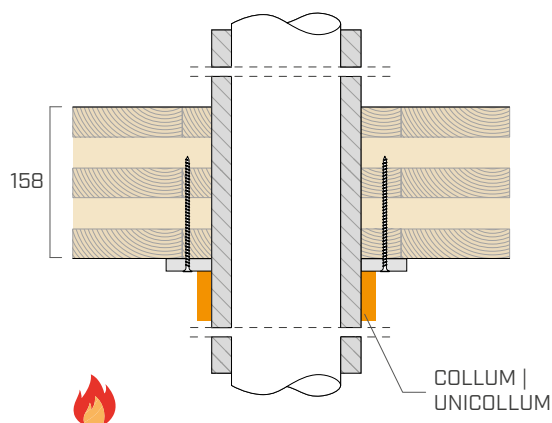

PENETRATION

TYPES	Insulated steel pipework
PIPE DIAMETER	≤ 50 mm
PIPE INSULATION	≤ 16.5 mm
HOLE DIMENSION	Equal to the pipe diameter

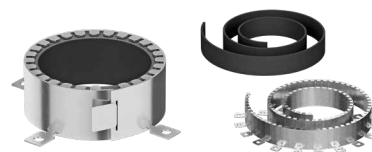

COLLUM

UNICOLLUM

PERFORMANCE CRITERIA

COLLUM or **UNICOLLUM** applied only on the side exposed to fire

DIAMETER	PIPE WALL THICKNESS	INSULATION THICKNESS	
[mm]	[mm]	[mm]	
≤ 50	≥ 1,25	16,5	

Reference standard: EN 1363-1| EN 1366-3

INSTALLATION

- Create a 12.5 mm thick F-type plasterboard frame (single sheet) on the side exposed to fire
- Install **COLLUM** or **UNICOLLUM** in accordance with the technical data sheet
- Fasten **COLLUM** or **UNICOLLUM** to the plasterboard frame using wire and self-tapping screws.

PENETRATION h158 | 9 - TEST REPORT

OVERSIZED HOLE PENETRATION ON CLT FLOOR WITH INSULATED STEEL PIPE AND MASS

UNEXPOSED SIDE	no product
EXPOSED SIDE	no product
INFILL	MASS
Description	Intumescent brick
Material	Intumescent polyurethane sponge
Reference ETA	ETA 24/1205

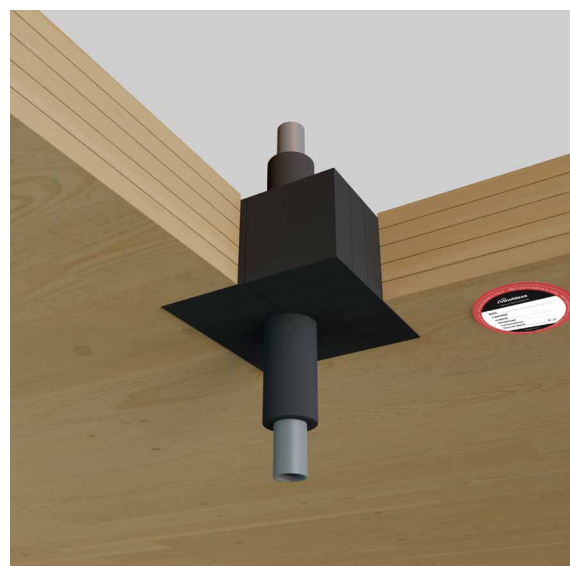
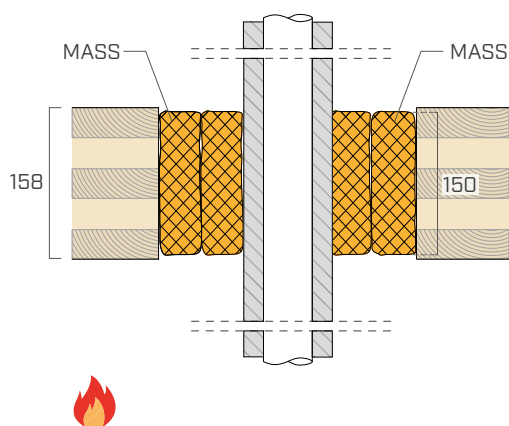

PENETRATION

TYPES	Insulated steel pipework
PIPE DIAMETER	≤ 50 mm
PIPE INSULATION	≤ 16.5 mm
HOLE DIMENSION	≤ 700 x 300 mm



MASS

PERFORMANCE CRITERIA

DIAMETER [mm]	PIPE WALL THICKNESS [mm]	INSULATION THICKNESS [mm]	
≤ 50	1,25	16,5	

Reference standard: EN 1363-1 | EN 1366-3
 (*)EI = tightness and insulation, E = tightness

INSTALLATION

- Fill the perimeter gap of the pipe by applying suitably shaped **MASS** inside the thickness of the floor. If appropriate, create a support mesh for the product.

PENETRATION h158 | 10 - TEST REPORT

OVERSIZED HOLE PENETRATION ON CLT FLOOR WITH STEEL PIPE AND FIRE STRIPE GRAPHITE PRO + PANEL

UNEXPOSED SIDE	no product	
EXPOSED SIDE	FIRE STRIPE GRAPHITE PRO	
Description	Fireproof tape	
Material	Intumescent sheath 4 mm thick	
INFILL	PANEL	SEAL W
Description	Panel with fireproof coating	Fireproof acrylic sealant
Material	Rock wool with ablative treatment	Acrylic polymers
Reference ETA	ETA 24/1206	ETA 24/1207

complementary product for sealing

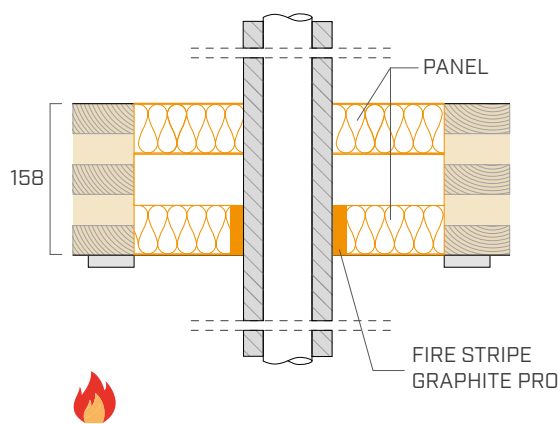

PENETRATION

TYPES	Insulated steel pipework
PIPE DIAMETER	≤ 50 mm
PIPE INSULATION	≤ 16.5 mm
HOLE DIMENSION	≤ 700 x 500 mm

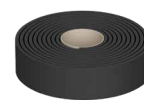

FIRE STRIPE GRAPHITE PRO



PANEL



SEAL W

PERFORMANCE CRITERIA

FIRE STRIPE GRAPHITE PRO applied only on the side exposed to fire

DIAMETER	PIPE WALL THICKNESS	INSULATION THICKNESS	 EI 120
[mm]	[mm]	[mm]	
≤ 50	1,25	16,5	

Reference standard: EN 1363-1| EN 1366-3

INSTALLATION

- Create a 12.5 mm thick F-type plasterboard frame (single sheet) on the side exposed to fire
- Wrap **FIRE STRIPE GRAPHITE PRO** around the pipe
- Fasten **FIRE STRIPE GRAPHITE PRO** with adhesive tape and position it at the penetration on the fire side
- Fill the perimeter gap with two layers of **PANEL** and seal with **SEAL W**. If necessary, create a support mesh for the products.

PENETRATION h158 | 11 - TEST REPORT

CALIBRATED HOLE PENETRATION ON CLT FLOOR WITH STEEL PIPE AND PANNUS

UNEXPOSED SIDE	PANNUS
Description	Fireproof covering for metal pipes
Material	Incombustible mineral wool fabric and ablative cooling treatment
EXPOSED SIDE	no product

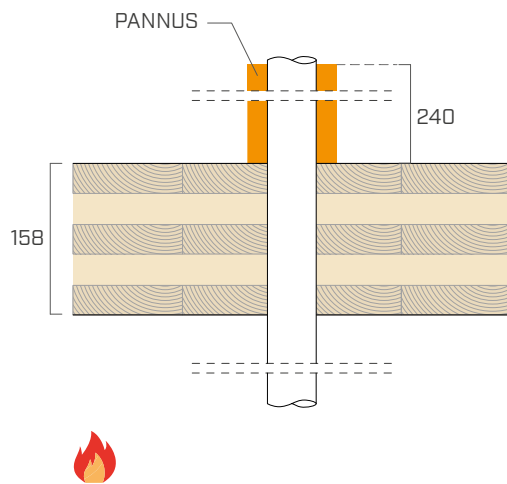

PENETRATION

TYPES	Steel pipe
PIPE DIAMETER	≤ 50 mm
PIPE INSULATION	without insulation
HOLE DIMENSION	Equal to the pipe diameter



PANNUS

PERFORMANCE CRITERIA

PANNUS applied only on the side not exposed to fire

DIAMETER	PIPE WALL THICKNESS	NUMBER OF WINDINGS	
[mm]	[mm]	[mm]	
≤ 50	≥ 1,5	1 x 240	

Reference standard: EN 1363-1| EN 1366-3

INSTALLATION

- Wrap the pipe with a layer of **PANNUS** adhering to the side not exposed to fire
- Fasten **PANNUS** with a wire coil.

PENETRATION h158 | 12 - TEST REPORT

OVERSIZED HOLE PENETRATION ON CLT FLOOR WITH STEEL PIPE AND PANNUS + MASS

UNEXPOSED SIDE	PANNUS
Description	Fireproof covering for metal pipes
Material	Incombustible mineral wool fabric and ablative cooling treatment
EXPOSED SIDE	no product
INFILL	MASS
Description	Intumescent brick
Material	Intumescent polyurethane sponge
Reference ETA	ETA 24/1205

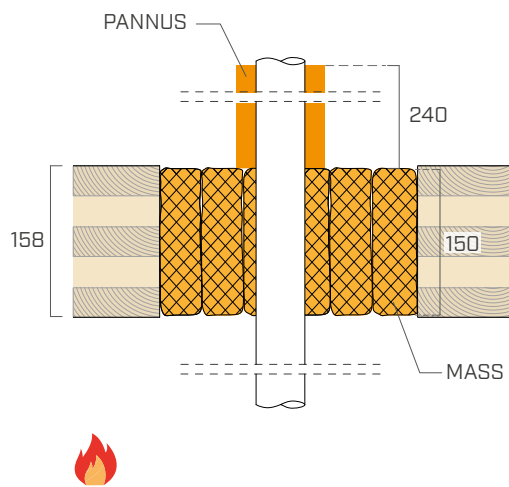

PENETRATION

TYPES	Steel pipe
PIPE DIAMETER	≤ 50 mm
PIPE INSULATION	Without insulation
HOLE DIMENSION	≤ 700 x 300 mm



PANNUS



MASS

PERFORMANCE CRITERIA

PANNUS applied only on the side not exposed to fire

DIAMETER [mm]	PIPE WALL THICKNESS [mm]	NUMBER OF WINDINGS [mm]	
≤ 50	≥ 1,5	1 x 240	

Reference standard: EN 1363-1 | EN 1366-3
 (*) EI = tightness and insulation, E = tightness

INSTALLATION

- Fill the perimeter gap around the pipe by applying appropriately shaped **MASS**. If appropriate, create a support mesh for the product
- Wrap the pipe with a layer of **PANNUS** adhering to the side not exposed to fire
- Fasten **PANNUS** with a wire coil.

PENETRATION h158 | 13 - TEST REPORT

OVERSIZED HOLE PENETRATION ON CLT FLOOR WITH STEEL PIPE AND PANNUS + PANEL

UNEXPOSED SIDE	PANNUS	
Description	Fireproof covering for metal pipes	
Material	Incombustible mineral wool fabric and ablative cooling treatment	
EXPOSED SIDE	no product	
INFILL	PANEL	SEAL W
Description	Panel with fireproof coating	Fireproof acrylic sealant
Material	Rock wool with ablative treatment	Acrylic polymers
Reference ETA	ETA 24/1206	ETA 24/1207

complementary product for sealing

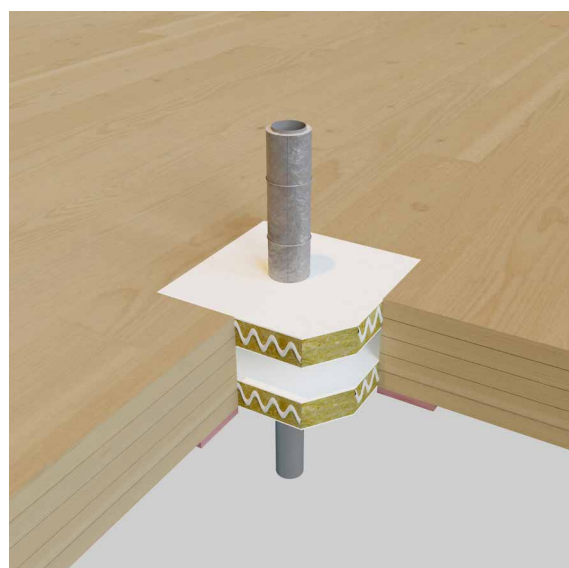
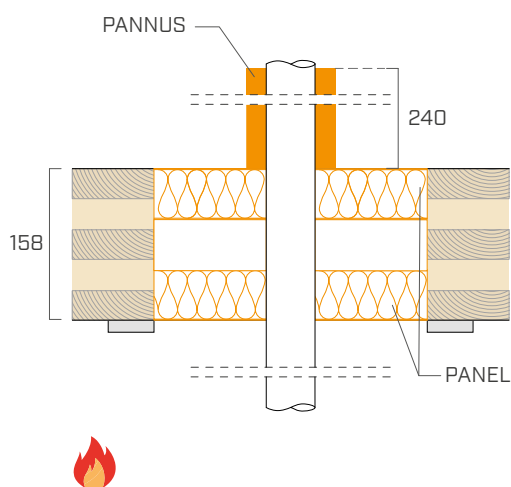

PENETRATION

TYPES	Steel pipe
PIPE DIAMETER	≤ 50 mm
PIPE INSULATION	without insulation
HOLE DIMENSION	≤ 700 x 500 mm

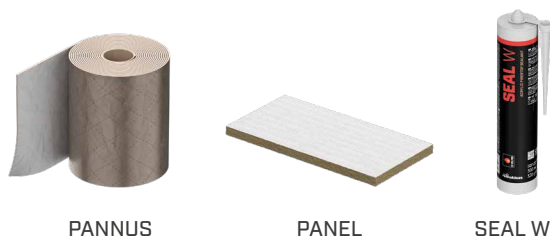

PERFORMANCE CRITERIA

PANNUS applied only on the side not exposed to fire

DIAMETER	PIPE WALL THICKNESS	NUMBER OF WINDINGS	
[mm]	[mm]	[mm]	
≤ 50	≥ 1,25	1 x 240	

Reference standard: EN 1363-1| EN 1366-3

INSTALLATION

- Create a 12.5 mm thick F-type plasterboard frame (single sheet) on the side exposed to fire
- Fill the perimeter gap with double-layer **PANEL** and seal with **SEAL W**. If appropriate, create a supporting mesh for the product
- Wrap the pipe with a layer of **PANNUS** adhering to the side not exposed to fire.
- Fasten **PANNUS** with a wire coil.

PENETRATION h158 | 14 - TEST REPORT

CALIBRATED HOLE PENETRATION ON CLT FLOOR WITH ELECTRICAL CABLES IN COMBUSTIBLE PIPES AND COLLUM OR UNICOLLUM

UNEXPOSED SIDE	no product	
EXPOSED SIDE	COLLUM	UNICOLLUM
Description	Fireproof collar	Fireproof collar in roll
Material	Stainless steel metal strip + intumescent sheath	Stainless steel metal strip + intumescent sheath
Reference ETA	ETA 24/1204	ETA 24/1203

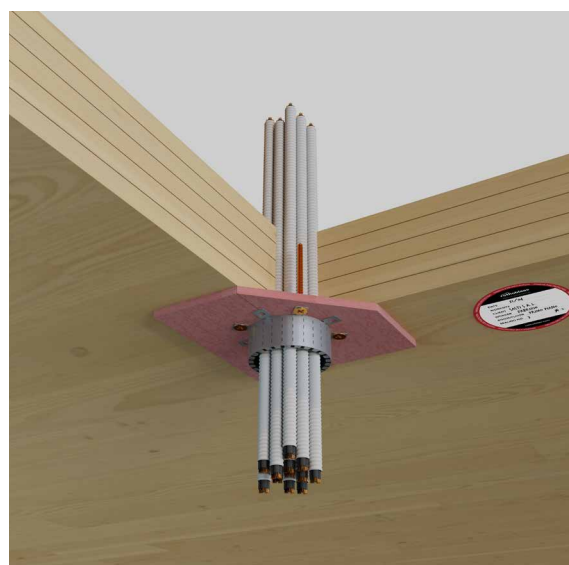
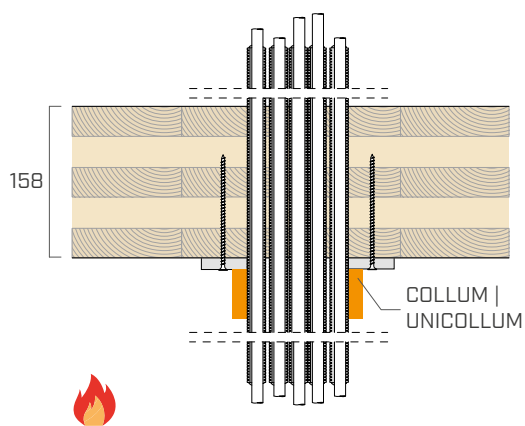

PENETRATION

TYPES	electrical cables in combustible pipes
PIPE DIAMETER	≤ 110 mm
HOLE DIMENSION	Equal to the pipe diameter

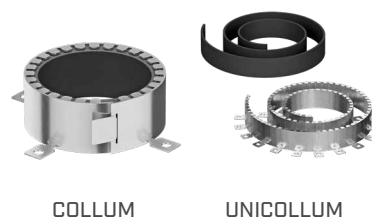

PERFORMANCE CRITERIA

COLLUM or UNICOLLUM applied only on the side exposed to fire

TYPE OF PENETRATION SYSTEM	OVERALL DIAMETER	PIPE DIAMETER	PIPE WALL THICKNESS	INSULATION THICKNESS	
	[mm]	[mm]	[mm]	[mm]	
20 corrugated PVC pipes with A3-type cable	≤ 110	≤ 20	2,0	-	

Reference standard: EN 1363-1| EN 1366-3

INSTALLATION

- Create a 12.5 mm thick F-type plasterboard frame (single sheet) on the side exposed to fire
- Install **COLLUM** or **UNICOLLUM** in accordance with the technical data sheet
- Fasten **COLLUM** or **UNICOLLUM** to the plasterboard frame using self-tapping screws.

PENETRATION h158 | 15 - TEST REPORT

OVERSIZED HOLE PENETRATION ON CLT FLOOR WITH ELECTRICAL CABLES IN COMBUSTIBLE PIPES AND COLLUM OR UNICOLLUM + PANEL

UNEXPOSED SIDE	no product	
EXPOSED SIDE	COLLUM	UNICOLLUM
Description	Fireproof collar	Fireproof collar in roll
Material	Stainless steel metal strip + intumescent sheath	Stainless steel metal strip + intumescent sheath
Reference ETA	ETA 24/1204	ETA 24/1203
INFILL	PANEL	SEAL W
Description	Panel with fireproof coating	Fireproof acrylic sealant
Material	Rock wool with ablative treatment	Acrylic polymers
Reference ETA	ETA 24/1206	ETA 24/1207

or

complementary product for sealing

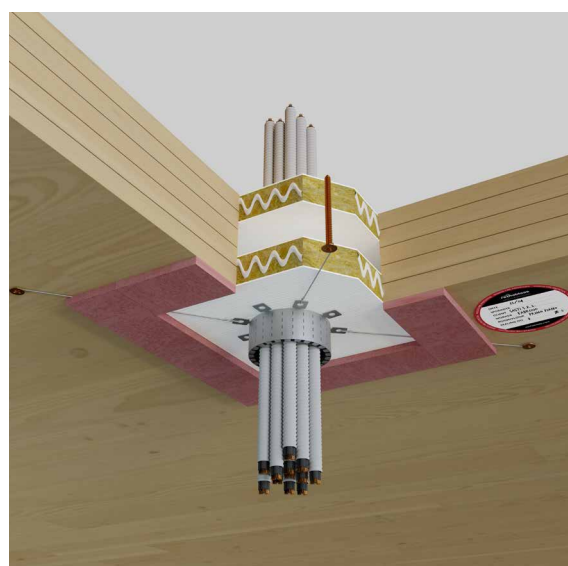
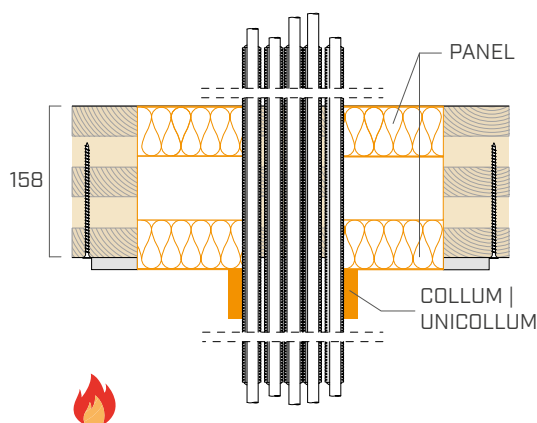

PENETRATION

TYPES	electrical cables in combustible pipes
PIPE DIAMETER	≤ 110 mm
HOLE DIMENSION	≤ 700 x 500 mm

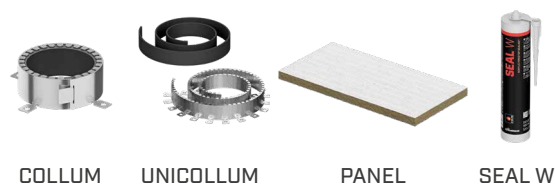

PERFORMANCE CRITERIA

COLLUM or **UNICOLLUM** applied only on the side exposed to fire

TYPE OF PENETRATION SYSTEM	OVERALL DIAMETER [mm]	PIPE DIAMETER [mm]	PIPE WALL THICKNESS [mm]	INSULATION THICKNESS [mm]	
20 corrugated PVC pipes with A3-type cable	≤ 110	≤ 20	2,0	-	

Reference standard: EN 1363-1 | EN 1366-3

INSTALLATION

- Create a 12.5 mm thick F-type plasterboard frame (single sheet) on the side exposed to fire
- Fill the perimeter gap of the pipe with double-layer **PANEL** and seal with **SEAL W**. If appropriate, create a support mesh for the product
- Install **COLLUM** or **UNICOLLUM** in accordance with the technical data sheet
- Fasten **COLLUM** or **UNICOLLUM** to the plasterboard frame using wire and self-tapping screws.

PENETRATIONh158 | 16 - TEST REPORT

OVERSIZED HOLE PENETRATION ON CLT FLOOR WITH ELECTRICAL CABLES IN COMBUSTIBLE PIPES AND GRAPHIT FOAM

UNEXPOSED SIDE	no product
EXPOSED SIDE	no product
INFILL	GRAPHIT FOAM
Description	Fireproof collar
Material	Stainless steel metal strip + intumescent sheath
Reference ETA	ETA 24/1204

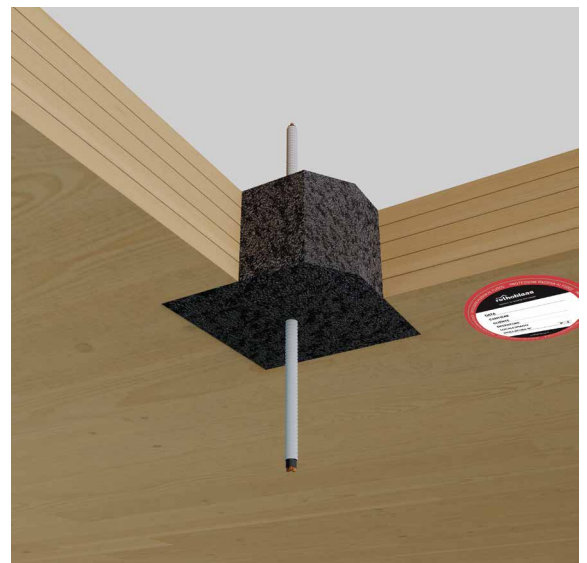
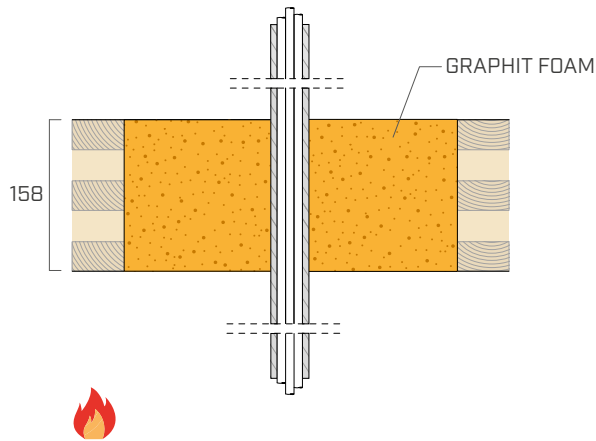

PENETRATION

TYPES	electrical cables in combustible pipes
PIPE DIAMETER	≤ 20 mm
HOLE DIMENSION	≤ 300 x 250 mm



GRAPHIT FOAM

PERFORMANCE CRITERIA

TYPE OF PENETRATION SYSTEM	PIPE DIAMETER	
PVC corrugated pipe with FG16OR 16 type cable	[mm] ≤ 20	
Reference standard: EN 1363-1 EN 1366-3		

INSTALLATION

- Preparing the support formwork for foam
- Apply **GRAPHIT FOAM** starting from the furthest point, do not interrupt the extrusion to avoid hardening of the material in the mixer. Do not immerse the nozzle in the extruded product
- Wait for the product to fully expand. If appropriate, create a support mesh for the product.

PENETRATION h158 | 17 - TEST REPORT

OVERSIZED HOLE PENETRATION ON CLT FLOOR WITH ELECTRICAL CABLES IN COMBUSTIBLE PIPES AND FIRE STRIPE GRAPHITE PRO + PANEL

UNEXPOSED SIDE	no product	
EXPOSED SIDE	FIRE STRIPE GRAPHITE PRO	
Description	Fireproof tape	
Material	Intumescent sheath 4 mm thick	
INFILL	PANEL	SEAL W
Description	Panel with fireproof coating	Fireproof acrylic sealant
Material	Rock wool with ablative treatment	Acrylic polymers
Reference ETA	ETA 24/1206	ETA 24/1207

complementary product for sealing

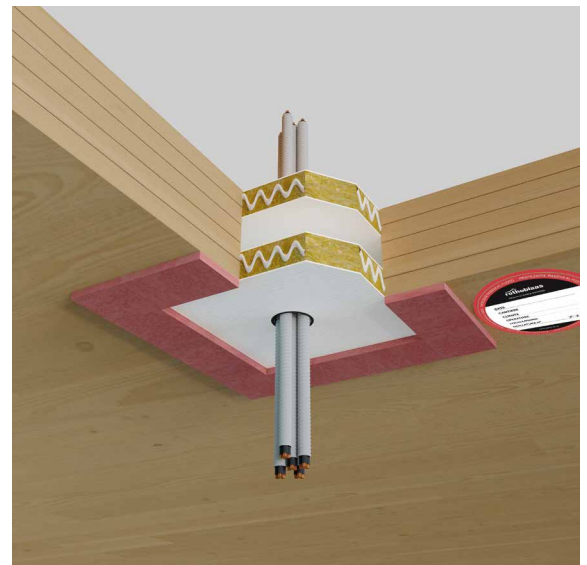
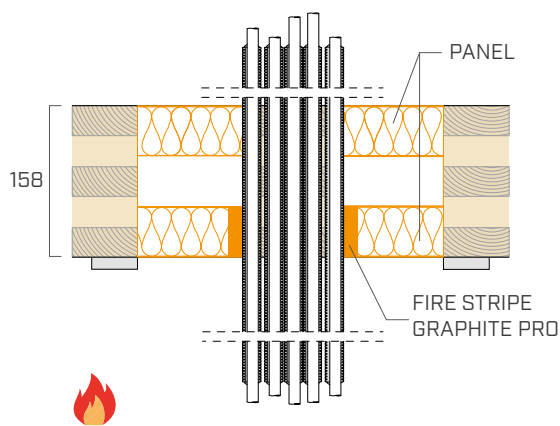

PENETRATION

TYPES	electrical cables in combustible pipes
PIPE DIAMETER	≤ 20 mm
HOLE DIMENSION	≤ 700 x 500 mm

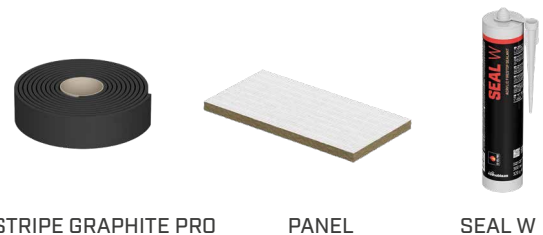

FIRE STRIPE GRAPHITE PRO

PANEL

SEAL W

PERFORMANCE CRITERIA

FIRE STRIPE GRAPHITE PRO applied only on the side exposed to fire

TYPE OF PENETRATION SYSTEM	PIPE DIAMETER [mm]	NUMBER OF WINDINGS [mm]	
5 PVC corrugated pipes with FG16OR 16 type cable	≤ 20	2 x 50	

Reference standard: EN 1363-1| EN 1366-3

INSTALLATION

- Create a 12.5 mm thick F-type plasterboard frame (single sheet) on the side exposed to fire
- Wrap two layers of FIRE STRIPE GRAPHITE PRO around the pipe
- Fasten FIRE STRIPE GRAPHITE PRO with adhesive tape and position it at the penetration on the fire side
- Fill the perimeter gap with two layers of PANEL and seal with SEAL W. If necessary, create a support mesh for the products.

PENETRATION h158 | 18 - TEST REPORT

OVERSIZED HOLE PENETRATION ON CLT FLOOR WITH CABLE TRAY AND MASS

UNEXPOSED SIDE	no product
EXPOSED SIDE	no product
INFILL	MASS
Description	Intumescent brick
Material	Intumescent polyurethane sponge
Reference ETA	ETA 24/1205

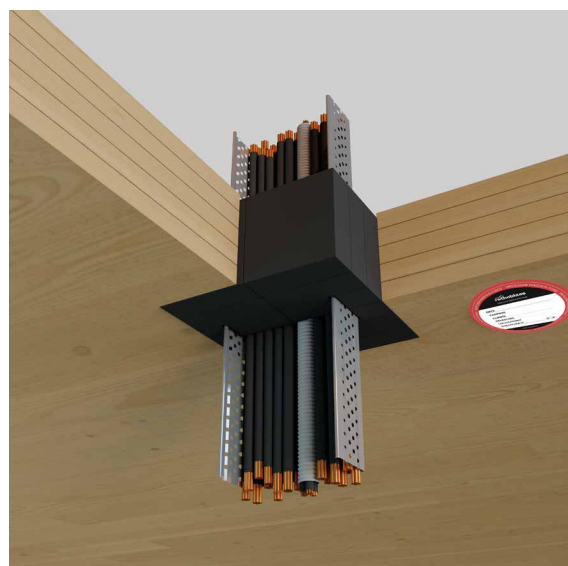
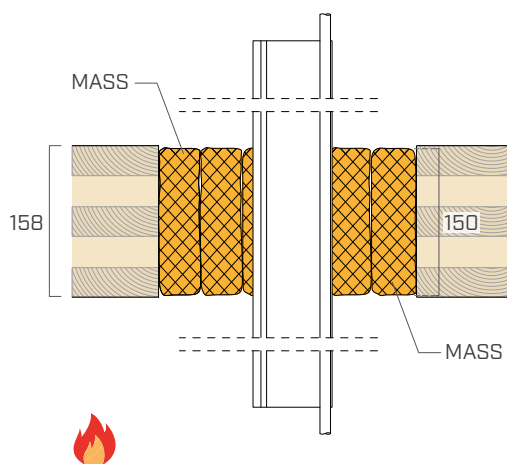

PENETRATION

TYPES	Metal cable tray
CABLE TRAY SIZE	300 x 80 mm
HOLE DIMENSION	≤ 700 x 300 mm



MASS

PERFORMANCE CRITERIA

TYPE OF PENETRATION SYSTEM	CABLE TRAY SIZE [mm]	PIPE DIAMETER [mm]	
10 H07RN-F 5G1.5	300 x 80	≤ 21	
10 FG16OR 16 5G1.5			
10 H05VV-F 5G1.5			
2 FG16R16 1x95			

Reference standard: EN 1363-1 | EN 1366-3

(*) EI = tightness and insulation, E = tightness

INSTALLATION

- Fill the gap by applying suitably shaped **MASS** with the 150 mm side within the thickness of the floor. If appropriate, create a support mesh for the product.

PENETRATION h158 | 19 - TEST REPORT

OVERSIZED HOLE PENETRATION ON CLT FLOOR WITH CABLE TRAY AND SACCUS + PANEL

UNEXPOSED SIDE	no product	
EXPOSED SIDE	no product	
INFILL	SACCUS	SEAL W
Description	Fireproof bearing	Fireproof acrylic sealant
Material	Fibreglass bag containing intumescent, water-releasing granular compounds	Acrylic polymers
Reference ETA	ETA 24/1082	ETA 24/1207
INFILL	PANEL	SEAL W
Description	Panel with fireproof coating	Fireproof acrylic sealant
Material	Rock wool with ablative treatment	Acrylic polymers
Reference ETA	ETA 24/1206	ETA 24/1207

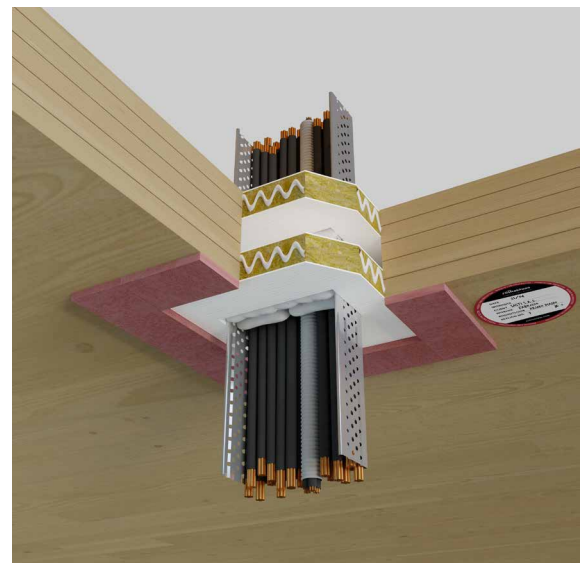
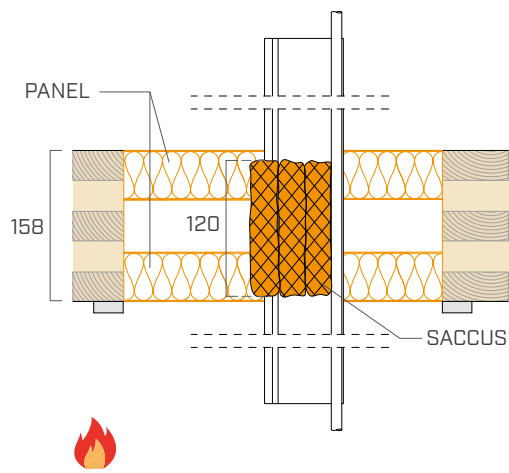

PENETRATION

TYPES	Metal cable tray
CABLE TRAY SIZE	300 x 80 mm
HOLE DIMENSION	≤ 700 x 500 mm

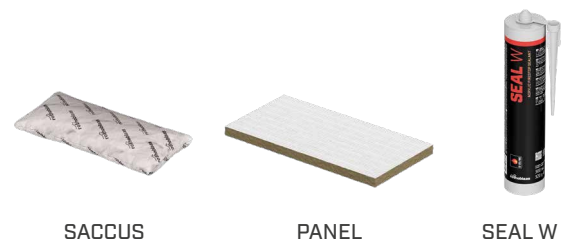

PERFORMANCE CRITERIA

TYPE OF PENETRATION SYSTEM	CABLE TRAY SIZE [mm]	PIPE DIAMETER [mm]	
10 H07RN-F 5G1.5	300 x 80	≤ 21	
10 FG16OR 16 5G1.5			
10 H05VV-F 5G1.5			
2 FG16R16 1x95			

Reference standard: EN 1363-1 | EN 1366-3

INSTALLATION

- Create a 12.5 mm thick F-type plasterboard frame (single sheet) on the side exposed to fire
- Fill the gap of the cable tray with **SACCUS** with the 120 mm side inside the slab thickness and seal with **SEAL W**.
- Fill the perimeter gap with two layers of **PANEL** and seal with **SEAL W**. If necessary, create a support mesh for the products.

PENETRATION h158 | 20 - TEST REPORT

OVERSIZED HOLE PENETRATION ON CLT FLOOR WITH CABLE TRAY AND GRAPHIT FOAM

UNEXPOSED SIDE	no product
EXPOSED SIDE	no product
INFILL	GRAPHIT FOAM
Description	Polyurethane foam
Material	Two-component foam with graphite additive

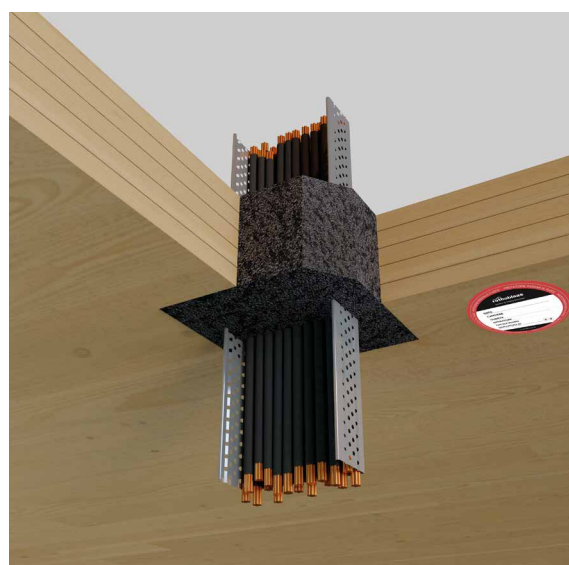
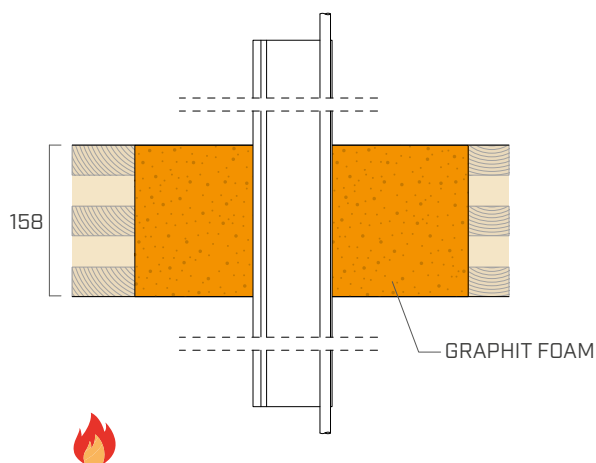

PENETRATION

TYPES	Metal cable tray
CABLE TRAY SIZE	150 x 80 mm
HOLE DIMENSION	≤ 300 x 250 mm



GRAPHIT FOAM

PERFORMANCE CRITERIA

TYPE OF PENETRATION SYSTEM	CABLE TRAY SIZE [mm]	PIPE DIAMETER [mm]	
10 H07RN-F 5G1.5	300 x 80	≤ 21	
10 FG16OR 16 5G1.5			
10 H05VV-F 5G1.5			

Reference standard: EN 1363-1| EN 1366-3

INSTALLATION

- Preparing the support formwork for foam.
- Apply **GRAPHIT FOAM** starting from the furthest point, do not interrupt the extrusion to avoid hardening of the material in the mixer. Do not immerse the nozzle in the extruded product.
- Wait for the product to fully expand. If appropriate, create a support mesh for the product.

PENETRATION v_lw | 1 - TEST REPORT

CALIBRATED HOLE PENETRATION ON SELF-SUPPORTING PARTITION WITH COMBUSTIBLE PIPE AND COLLUM OR UNICOLLUM

UNEXPOSED SIDE	no product	
EXPOSED SIDE	COLLUM	UNICOLLUM
Description	Fireproof collar	Fireproof collar in roll
Material	Stainless steel metal strip + intumescent sheath	Stainless steel metal strip + intumescent sheath
Reference ETA	ETA 24/1204	ETA 24/1203

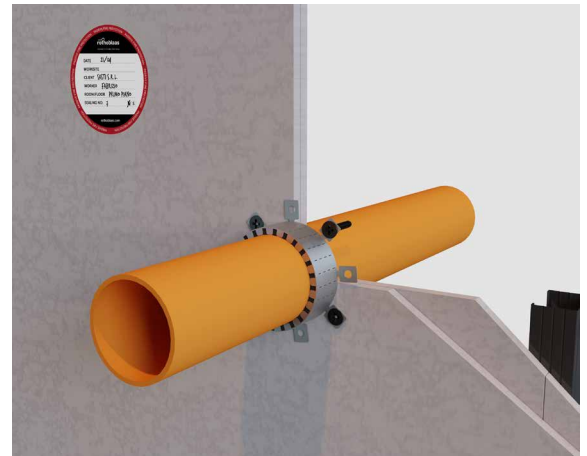
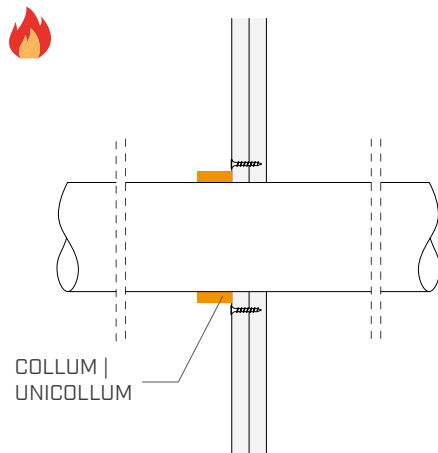

PENETRATION

TYPES	Combustible pipes
PIPE DIAMETER	≤ 160 mm
PIPE INSULATION	without insulation
HOLE DIMENSION	Equal to the pipe diameter

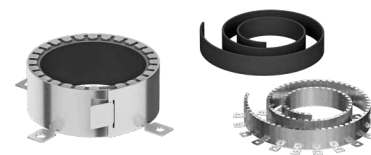

COLLUM

UNICOLLUM

PERFORMANCE CRITERIA

COLLUM or UNICOLLUM applied only on the side exposed to fire

WALL WITH THICKNESS ≥ 30 mm [15 mm THICK F-TYPE DOUBLE PLASTERBOARD SHEET]

TYPE OF PENETRATION SYSTEM	PIPE DIAMETER	PIPE WALL THICKNESS	
	[mm]	[mm]	
HDPE, PE, ABS, SAN + PVC	≤ 110	12,3	
PP	≤ 110	12,3	
PVC	≤ 110	8,1	
	110 < Ø ≤ 160	9,5	
PPR	≤ 110	15,1	

Reference standard: EN 1363-1| EN 1366-3

WALL WITH THICKNESS ≥ 50 mm [25 mm THICK F-TYPE DOUBLE PLASTERBOARD SHEET]

TYPE OF PENETRATION SYSTEM	PIPE DIAMETER	PIPE WALL THICKNESS	
	[mm]	[mm]	
PVC	≤ 110	8,1	
	110 < Ø ≤ 160	11,8	

Reference standard: EN 1363-1| EN 1366-3

INSTALLATION

- Install **COLLUM** or **UNICOLLUM** in accordance with the technical data sheet
- Fasten **COLLUM** or **UNICOLLUM** using self-tapping screws.

PENETRATION v_lw | 2 - TEST REPORT

OVERSIZED HOLE PENETRATION ON SELF-SUPPORTING PARTITION WITH MULTI-LAYER INSULATED PIPE AND COLLUM OR UNICOLLUM + PANEL

UNEXPOSED SIDE	no product	
EXPOSED SIDE	COLLUM	UNICOLLUM
Description	Fireproof collar	Fireproof collar in roll
Material	Stainless steel metal strip + intumescent sheath	Stainless steel metal strip + intumescent sheath
Reference ETA	ETA 24/1204	ETA 24/1203
INFILL	PANEL	SEAL W
Description	Panel with fireproof coating	Fireproof acrylic sealant
Material	Rock wool with ablative treatment	Acrylic polymers
Reference ETA	ETA 24/1206	ETA 24/1207

complementary product for sealing

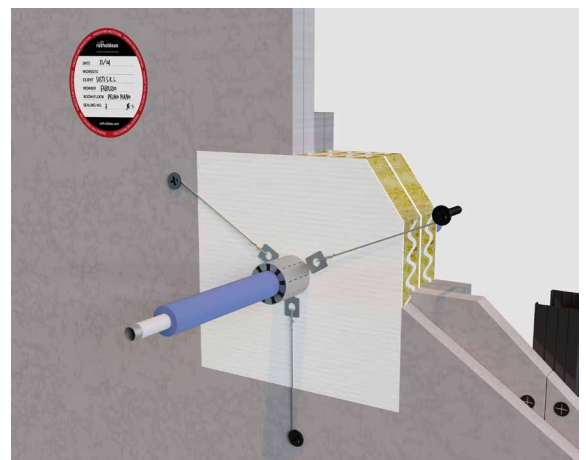
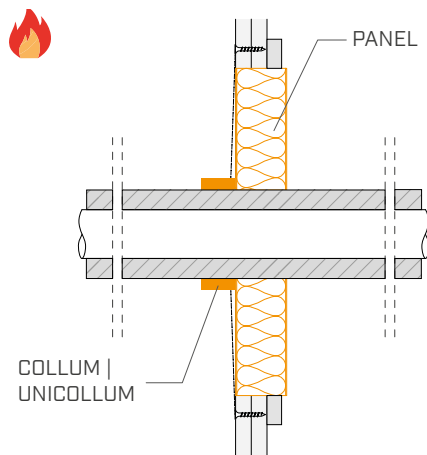

PERFORMANCE CRITERIA



COLLUM or **UNICOLLUM** applied only on the side exposed to fire

WALL WITH THICKNESS ≥ 30 mm [15 mm THICK F-TYPE DOUBLE PLASTERBOARD SHEET]

TYPE OF SYSTEM THROUGH	PIPE DIAMETER [mm]	PIPE WALL THICKNESS [mm]	INSULATION THICKNESS [mm]	
PE-X / AI / HDPE	≤ 16	2,0	9,0	

Reference standard: EN 1363-1| EN 1366-3

WALL WITH THICKNESS ≥ 50 mm [25 mm THICK F-TYPE DOUBLE PLASTERBOARD SHEET]

TYPE OF SYSTEM THROUGH	PIPE DIAMETER [mm]	PIPE WALL THICKNESS [mm]	INSULATION THICKNESS [mm]	
PE-X / AI / HDPE	≤ 16	2,0	9,0	
	≤ 20	3,0	≤ 6.0 (PE insulation)	

Reference standard: EN 1363-1| EN 1366-3

INSTALLATION

- Create an F-type plasterboard frame
- Fill the perimeter gap with **PANEL** (for EI60 single-layer, for EI120 double-layer) and seal with **SEAL W**.
- Install **COLLUM** or **UNICOLLUM** in accordance with the technical data sheet
- Fasten **COLLUM** or **UNICOLLUM** to the plasterboard frame using self-tapping screws.

PENETRATION v_lw | 3 - TEST REPORT

CALIBRATED HOLE PENETRATION ON SELF-SUPPORTING PARTITION WITH INSULATED STEEL PIPE AND COLLUM OR UNICOLLUM

UNEXPOSED SIDE	no product	
EXPOSED SIDE	COLLUM	UNICOLLUM
Description	Fireproof collar	Fireproof collar in roll
Material	Stainless steel metal strip + intumescent sheath	Stainless steel metal strip + intumescent sheath
Reference ETA	ETA 24/1204	ETA 24/1203

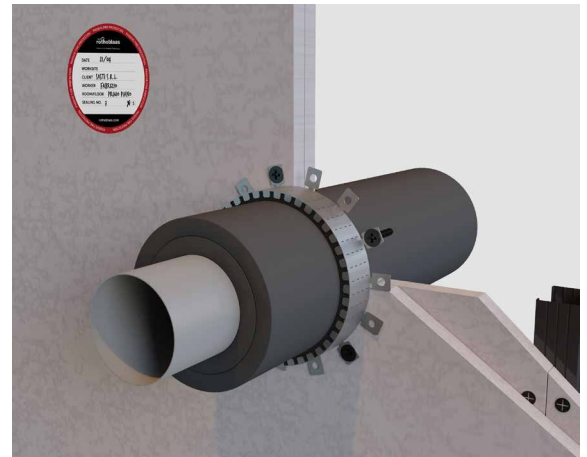
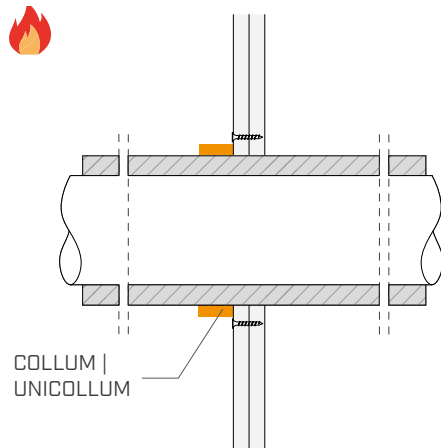

PENETRATION

TYPES	Steel pipe
PIPE DIAMETER	≤ 200 mm
PIPE INSULATION	≤ 40 mm
HOLE DIMENSION	Equal to the pipe diameter

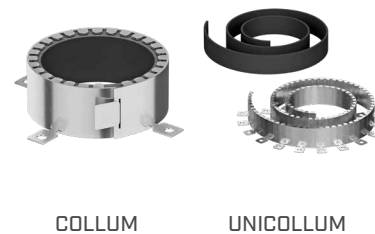

PERFORMANCE CRITERIA

COLLUM or **UNICOLLUM** applied only on the side exposed to fire

WALL WITH THICKNESS ≥ 30 mm [15 mm THICK F-TYPE DOUBLE PLASTERBOARD SHEET]

PIPE DIAMETER	WALL THICKNESS OF THE PIPELINES	INSULATION THICKNESS	
[mm]	[mm]	[mm]	
≤ 108	≥ 1,0	40,0	

Reference standard: EN 1363-1| EN 1366-3

WALL WITH THICKNESS ≥ 50 mm [25 mm THICK F-TYPE DOUBLE PLASTERBOARD SHEET]⁽¹⁾

PIPE DIAMETER	WALL THICKNESS OF THE PIPELINES	INSULATION THICKNESS	
[mm]	[mm]	[mm]	
≤ 200	≥ 4,0	40,0	

⁽¹⁾Create a 50 mm thick plasterboard frame with double F-type sheet.
Reference standard: EN 1363-1| EN 1366-3

INSTALLATION

- Install **COLLUM** or **UNICOLLUM** in accordance with the technical data sheet
- Fasten **COLLUM** or **UNICOLLUM** to the plasterboard frame using self-tapping screws.

PENETRATION v_lw | 4 - TEST REPORT

CALIBRATED HOLE PENETRATION ON SELF-SUPPORTING PARTITION WITH STEEL PIPE AND PANNUS

UNEXPOSED SIDE	PANNUS
Description	Fireproof covering for metal pipes
Material	Incombustible mineral wool fabric and ablative cooling treatment
EXPOSED SIDE	no product

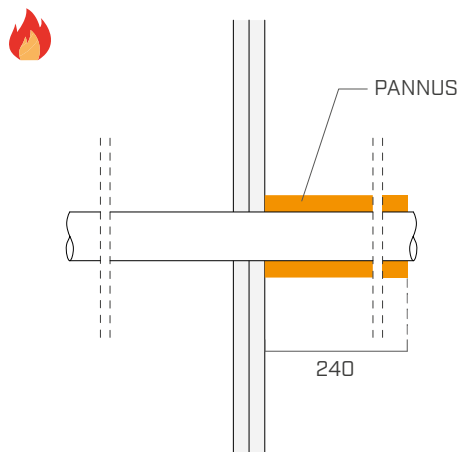

PENETRATION

TYPES	Steel pipe
PIPE DIAMETER	≤ 50 mm
PIPE INSULATION	Without insulation
HOLE DIMENSION	Equal to the pipe diameter



PANNUS

PERFORMANCE CRITERIA

PANNUS applied only on the side not exposed to fire

WALL WITH THICKNESS ≥ 30 mm [15 mm THICK F-TYPE DOUBLE PLASTERBOARD SHEET]

PIPE DIAMETER [mm]	WALL THICKNESS [mm]	NUMBER OF WINDINGS [mm]	
≤ 50	≥ 30	1 x 240	

Reference standard: EN 1363-1| EN 1366-3

INSTALLATION

- Wrap the pipe with a layer of **PANNUS** adhering to the side not exposed to fire
- Fasten **PANNUS** with a wire coil.

PENETRATION v_lw | 5 - TEST REPORT

OVERSIZED HOLE PENETRATION ON SELF-SUPPORTING PARTITION WITH INSULATED COPPER PIPE AND FIRE STRIPE GRAPHITE PRO + PANEL

UNEXPOSED SIDE	no product	
EXPOSED SIDE	FIRE STRIPE GRAPHITE PRO	
Description	Fireproof tape	
Material	Intumescent sheath 4 mm thick	
INFILL	PANEL	SEAL W
Description	Panel with fireproof coating	Fireproof acrylic sealant
Material	Rock wool with ablative treatment	Acrylic polymers
Reference ETA	ETA 24/1206	ETA 24/1207

complementary product for sealing

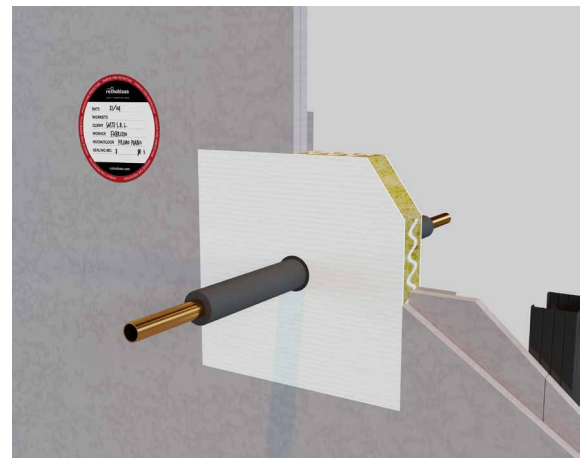
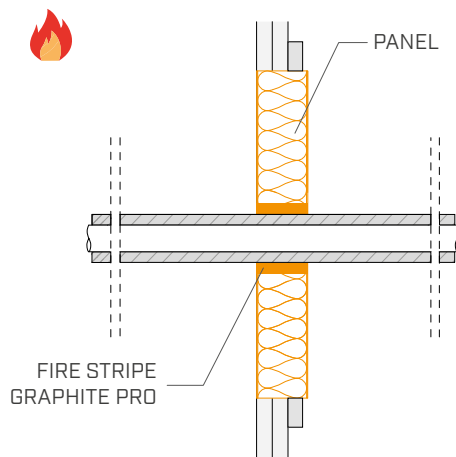

PENETRATION

TYPES	Insulated copper pipes
PIPE DIAMETER	≤ 20 mm
PIPE INSULATION	≤ 9 mm
HOLE DIMENSION	≤ 550 x 1050 mm

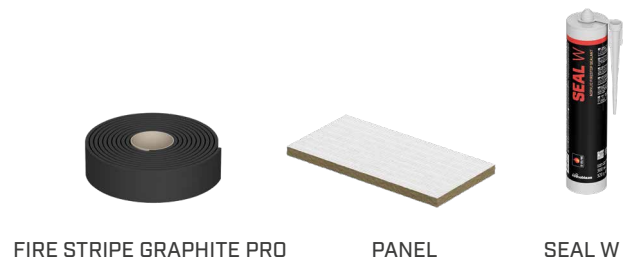

PERFORMANCE CRITERIA

WALL WITH THICKNESS ≥ 50 mm (25 mm THICK F-TYPE DOUBLE PLASTERBOARD SHEET)

BUNDLE SIZE [mm]	INSULATION THICKNESS [mm]	WALL THICKNESS [mm]	SLOT DIMENSIONS [b x h] [mm]	NO. PANEL	
≤ 20	≤ 20	≥ 50	≤ 550 x 1050	2	
≤ 21	≤ 9	≥ 30	≤ 500 x 1060	1	

Reference standard: EN 1363-1| EN 1366-3

INSTALLATION

- Create an F-type plasterboard frame
- Wrap **FIRE STRIPE GRAPHITE PRO** around the pipe
- Fasten **FIRE STRIPE GRAPHITE PRO** with adhesive tape and position it at the penetration on the fire side
- Fill the perimeter gap with **PANEL** (for EI60 single-layer, for EI120 double-layer) and seal with **SEAL W**.

PENETRATION v_lw | 6 - TEST REPORT

OVERSIZED HOLE PENETRATION ON SELF-SUPPORTING PARTITION WITH ELECTRICAL CABLES IN COMBUSTIBLE PIPES AND COLLUM OR UNICOLLUM + PANEL

UNEXPOSED SIDE	no product	
EXPOSED SIDE	COLLUM	UNICOLLUM
Description	Fireproof collar	Fireproof collar in roll
Material	Stainless steel metal strip + intumescent sheath	Stainless steel metal strip + intumescent sheath
Reference ETA	ETA 24/1204	ETA 24/1203
INFILL	PANEL	SEAL W
Description	Panel with fireproof coating	Fireproof acrylic sealant
Material	Rock wool with ablative treatment	Acrylic polymers
Reference ETA	ETA 24/1206	ETA 24/1207

complementary product for sealing

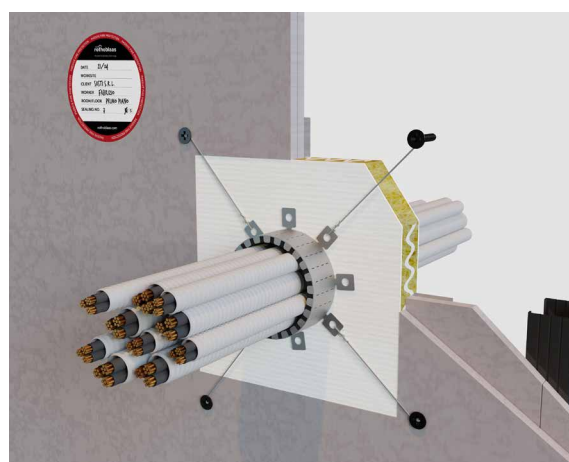
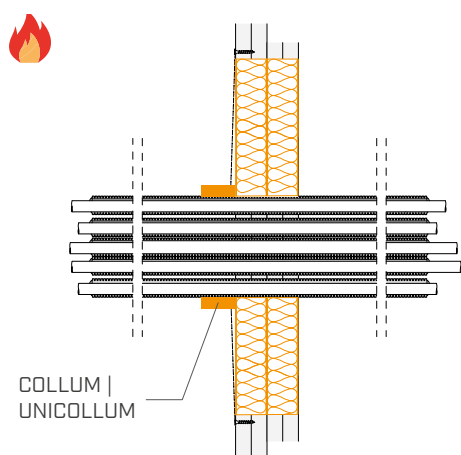

PERFORMANCE CRITERIA

COLLUM or **UNICOLLUM** applied only on the side exposed to fire

WALL WITH THICKNESS ≥ 30 mm [15 mm THICK F-TYPE DOUBLE PLASTERBOARD SHEET]

TYPE OF PENETRATION SYSTEM	OVERALL DIAMETER [mm]	PIPE DIAMETER [mm]	PIPE WALL THICKNESS [mm]	INSULATION THICKNESS [mm]	 EI60U/C
5 PE-X/Al/HDPE	≤ 110	≤ 16	2,0	9,0	
10 corrugated PVC pipes with A1-type cable		≤ 20	2,0	-	

Reference standard: EN 1363-1| EN 1366-3

WALL WITH THICKNESS ≥ 50 mm [25 mm THICK F-TYPE DOUBLE PLASTERBOARD SHEET]

TYPE OF PENETRATION SYSTEM	OVERALL DIAMETER [mm]	PIPE DIAMETER [mm]	PIPE WALL THICKNESS [mm]	INSULATION THICKNESS [mm]	 EI120C/C
3 PE-X/Al/HDPE	≤ 80	≤ 20	3,0	$\leq 6,0$ (PE insulation)	
3 corrugated PVC pipes with A1-type cable		≤ 26	3,0	-	

Reference standard: EN 1363-1| EN 1366-3

INSTALLATION

- Create an F-type plasterboard frame (for EI60 single sheet, for EI120 double sheet)
- Fill the perimeter gap with **PANEL** (for EI60 single-layer, for EI120 double-layer) and seal with **SEAL W**.
- Install **COLLUM** or **UNICOLLUM** in accordance with the technical data sheet
- Fasten **COLLUM** or **UNICOLLUM** to the plasterboard frame using self-tapping screws.

PENETRATION h_{fc} | 1 - TEST REPORT

CALIBRATED HOLE PENETRATION ON FALSE CEILING WITH COMBUSTIBLE PIPE AND COLLUM OR UNICOLLUM

UNEXPOSED SIDE	no product	
EXPOSED SIDE	COLLUM	UNICOLLUM
Description	Fireproof collar	Fireproof collar in roll
Material	Stainless steel metal strip + intumescent sheath	Stainless steel metal strip + intumescent sheath
Reference ETA	ETA 24/1204	ETA 24/1203

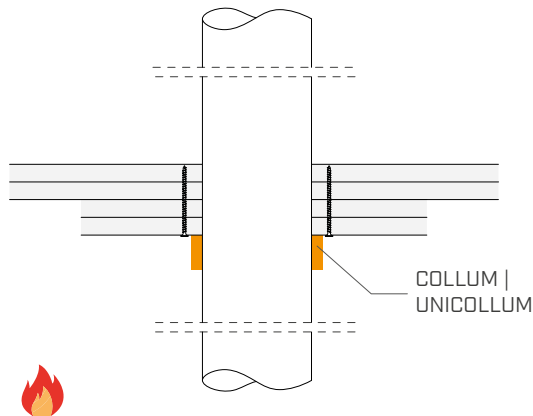

PENETRATION

TYPES	Combustible pipes
PIPE DIAMETER	≤ 250 mm
PIPE INSULATION	Without insulation
HOLE DIMENSION	Equal to the pipe diameter

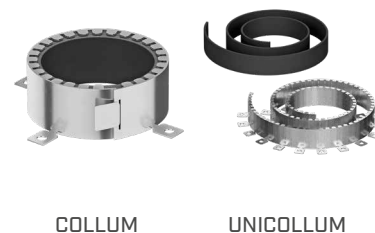

PERFORMANCE CRITERIA

COLLUM or **UNICOLLUM** applied only on the side exposed to fire

FALSE CEILING WITH THICKNESS ≥ 50 mm [25 mm thick F-type double plasterboard sheet]

TYPE OF PENETRATION SYSTEM	PIPE DIAMETER [mm]	PIPE WALL THICKNESS [mm]	
HDPE, PE, ABS, SAN + PVC	≤ 110	4,2 - 12,3	
	110 < Ø ≤ 160 ⁽¹¹⁾	18,4	
PP	≤ 110	2,7 - 18,2	
PVC	≤ 110	3,2 - 8,1	

(11) For pipe diameters greater than 110 mm, two COLLUMs must be installed adjacent to each other, attaching the sheet of the first COLLUM to the second COLLUM using self-drilling screws (see data sheet).

Reference standard: EN 1363-1 | EN 1366-3

INSTALLATION

- Create a 50 mm thick plasterboard frame with double F-type sheet
- Fill the perimeter gap with **PANEL** (for EI60 single layer, for EI120 double layer) and seal with **SEAL W**
- Install **COLLUM** or **UNICOLLUM** in accordance with the technical data sheet
- Fasten **COLLUM** or **UNICOLLUM** to the plasterboard frame using self-tapping screws.

PENETRATION h_{fc} | 2 - TEST REPORT

OVERSIZED HOLE PENETRATION ON FALSE CEILING WITH COMBUSTIBLE PIPE AND COLLUM OR UNICOLLUM + PANEL

UNEXPOSED SIDE	no product	
EXPOSED SIDE	COLLUM	UNICOLLUM
Description	Fireproof collar	Fireproof collar in roll
Material	Stainless steel metal strip + intumescent sheath	Stainless steel metal strip + intumescent sheath
Reference ETA	ETA 24/1204	ETA 24/1203
INFILL	PANEL	SEAL W
Description	Panel with fireproof coating	Fireproof acrylic sealant
Material	Rock wool with ablative treatment	Acrylic polymers
Reference ETA	ETA 24/1206	ETA 24/1207

complementary product for sealing

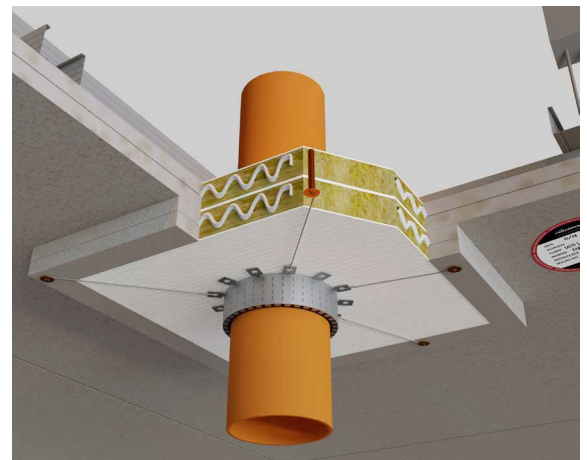
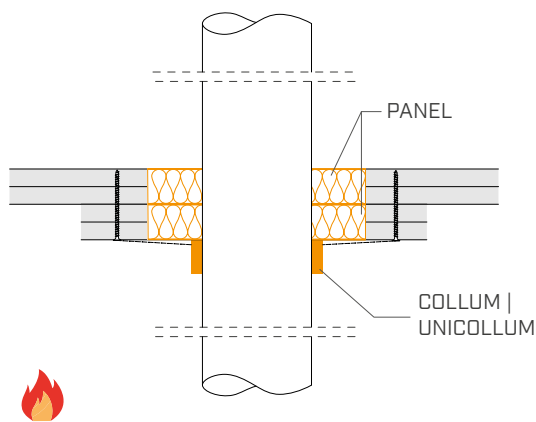

PERFORMANCE CRITERIA

COLLUM or **UNICOLLUM** applied only on the side exposed to fire

FALSE CEILING WITH THICKNESS ≥ 50 mm (25 mm thick F-type double plasterboard sheet)

TYPE OF PENETRATION SYSTEM	PIPE DIAMETER [mm]	PIPE WALL THICKNESS [mm]	
HDPE, PE, ABS, SAN + PVC	≤ 110	4,2 - 12,3	
	$110 < \varnothing \leq 250^{(18)}$	18,4	
PP	≤ 110	2,7 - 18,2	
PVC	≤ 110	3,2 - 8,1	

⁽¹⁸⁾ For pipe diameters greater than 110 mm, two COLLUMs must be installed adjacent to each other, attaching the sheet of the first COLLUM to the second COLLUM using self-drilling screws (see data sheet).
Reference standard: EN 1363-1| EN 1366-3

INSTALLATION

- Create a 50 mm thick plasterboard frame with double F-type sheet
- Fill the perimeter gap with **PANEL** (for EI60 single layer, for EI120 double layer) and seal with **SEAL W**
- Install **COLLUM** or **UNICOLLUM** in accordance with the technical data sheet
- Fasten **COLLUM** or **UNICOLLUM** to the plasterboard frame using self-tapping screws.

PENETRATION h_{fc} | 3 - TEST REPORT

CALIBRATED HOLE PENETRATION ON FALSE CEILING WITH MULTI-LAYER PIPE IN BUNDLES AND COLLUM OR UNICOLLUM

UNEXPOSED SIDE	no product	
EXPOSED SIDE	COLLUM	UNICOLLUM
Description	Fireproof collar	Fireproof collar in roll
Material	Stainless steel metal strip + intumescent sheath	Stainless steel metal strip + intumescent sheath
Reference ETA	ETA 24/1204	ETA 24/1203

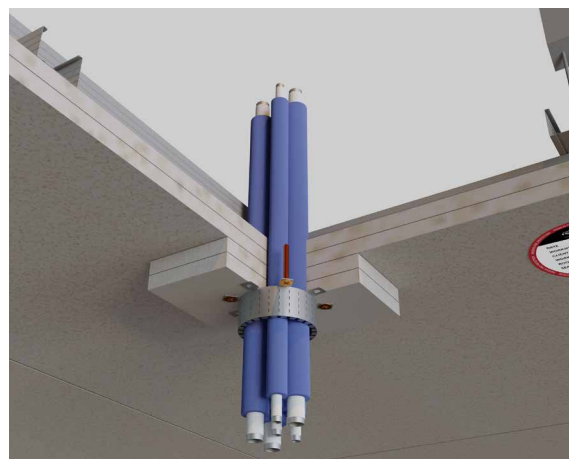
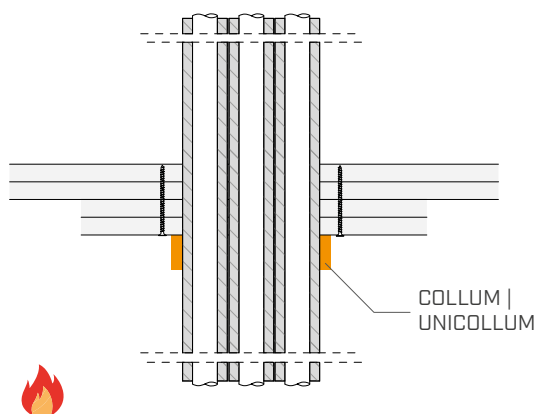

PENETRATION

TYPES	Multilayer insulated combustible line
PIPE DIAMETER	≤ 110 mm
PIPE INSULATION	≤ 9 mm
HOLE DIMENSION	Equal to the pipe diameter

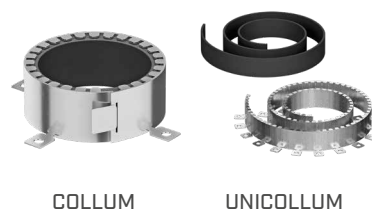

PERFORMANCE CRITERIA

COLLUM or UNICOLLUM applied only on the side exposed to fire

FALSE CEILING WITH THICKNESS ≥ 50 mm (25 mm thick F-type double plasterboard sheet)

TYPE OF PENETRATION SYSTEM	OVERALL DIAMETER [mm]	PIPE DIAMETER [mm]	PIPE WALL THICKNESS [mm]	INSULATION THICKNESS [mm]	 EI 120
2 PE-X / Al / PE-RT	≤ 110	≤ 16	2,0	≤ 6,0 (PE insulation)	
2 PE-X / Al / PE-RT		≤ 26	3,0	≤ 9,0 (PE insulation)	
2 corrugated PVC pipes with A1-type cable		≤ 21	2,0	-	

Reference standard: EN 1363-1| EN 1366-3

INSTALLATION

- Create a 50 mm thick plasterboard frame with double F-type sheet
- Fill the perimeter gap with **PANEL** (for EI60 single layer, for EI120 double layer) and seal with **SEAL W**
- Install **COLLUM** or **UNICOLLUM** in accordance with the technical data sheet
- Fasten **COLLUM** or **UNICOLLUM** to the plasterboard frame using self-tapping screws.

PENETRATION h_{fc} | 4 - TEST REPORT

CALIBRATED HOLE PENETRATION ON FALSE CEILING WITH INSULATED STEEL PIPE AND COLLUM OR UNICOLLUM

UNEXPOSED SIDE	no product	
EXPOSED SIDE	COLLUM	UNICOLLUM
Description	Fireproof collar	Fireproof collar in roll
Material	Stainless steel metal strip + intumescent sheath	Stainless steel metal strip + intumescent sheath
Reference ETA	ETA 24/1204	ETA 24/1203

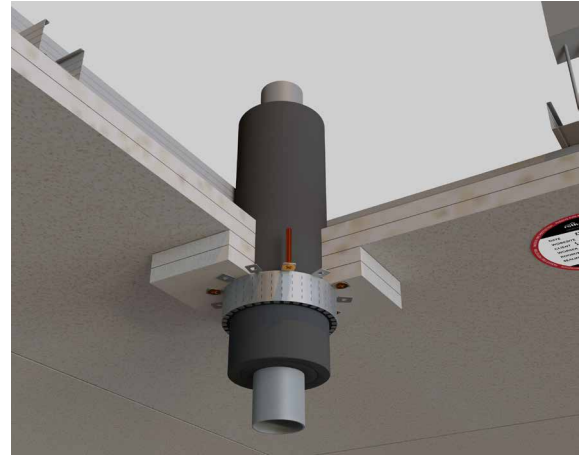
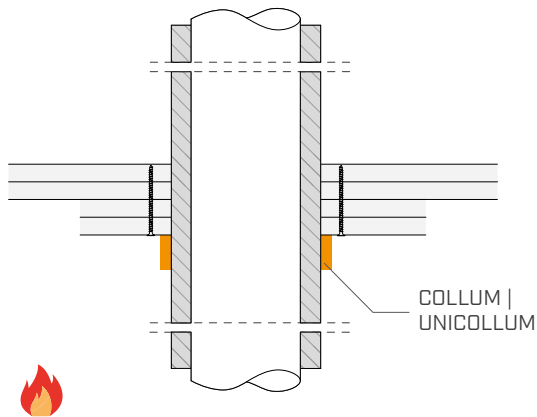

PENETRATION

TYPES	Insulated steel pipework
PIPE DIAMETER	≤ 108 mm
PIPE INSULATION	≤ 40 mm
HOLE DIMENSION	Equal to the pipe diameter

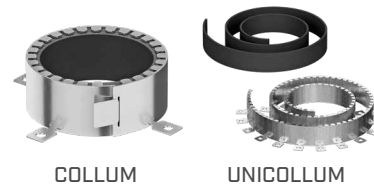

PERFORMANCE CRITERIA

COLLUM or **UNICOLLUM** applied only on the side exposed to fire

FALSE CEILING WITH THICKNESS ≥ 50 mm (25 mm thick F-type double plasterboard sheet)

PIPE DIAMETER [mm]	WALL THICKNESS [mm]	INSULATION THICKNESS [mm]	
≤ 108	≥ 4,0	20,0 - 40,0	

Reference standard: EN 1363-1 | EN 1366-3

INSTALLATION

- Create a 50 mm thick plasterboard frame with double F-type sheet
- Fill the perimeter gap with **PANEL** (for EI60 single layer, for EI120 double layer) and seal with **SEAL W**
- Install **COLLUM** or **UNICOLLUM** in accordance with the technical data sheet
- Fasten **COLLUM** or **UNICOLLUM** to the plasterboard frame using self-tapping screws.

PENETRATION h_{fc} | 5 - TEST REPORT

CALIBRATED HOLE PENETRATION ON FALSE CEILING WITH STEEL PIPE AND PANNUS

UNEXPOSED SIDE	PANNUS
Description	Fireproof covering for metal pipes
Material	Incombustible mineral wool fabric and ablative cooling treatment
EXPOSED SIDE	no product

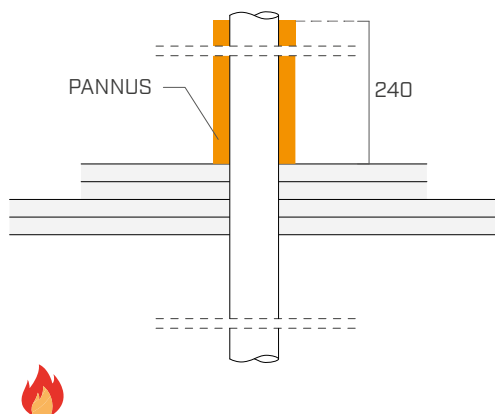

PENETRATION

TYPES	Steel pipe
PIPE DIAMETER	≤ 50 mm
PIPE INSULATION	Without insulation
HOLE DIMENSION	Equal to the pipe diameter



PANNUS

PERFORMANCE CRITERIA

PANNUS applied only on the side not exposed to fire

PIPE DIAMETER	PIPE WALL THICKNESS	NUMBER OF WINDINGS	
[mm]	[mm]	[mm]	
≤ 50	≥ 2	1 x 240	

Reference standard: EN 1363-1| EN 1366-3

INSTALLATION

- Create a 50 mm thick plasterboard frame with double F-type sheet
- Fill the perimeter gap with **PANEL** (for EI60 single layer, for EI120 double layer) and seal with **SEAL W**
- Install **COLLUM** or **UNICOLLUM** in accordance with the technical data sheet
- Fasten **COLLUM** or **UNICOLLUM** to the plasterboard frame using self-tapping screws.

PENETRATION h_{fc} | 6 - TEST REPORT

CALIBRATED HOLE PENETRATION ON FALSE CEILING WITH ELECTRICAL CABLES IN COMBUSTIBLE PIPES AND FIRE STRIPE GRAPHITE PRO

UNEXPOSED SIDE	no product
EXPOSED SIDE	FIRE STRIPE GRAPHITE PRO
Description	Fireproof tape
Material	Intumescent sheath 4 mm thick

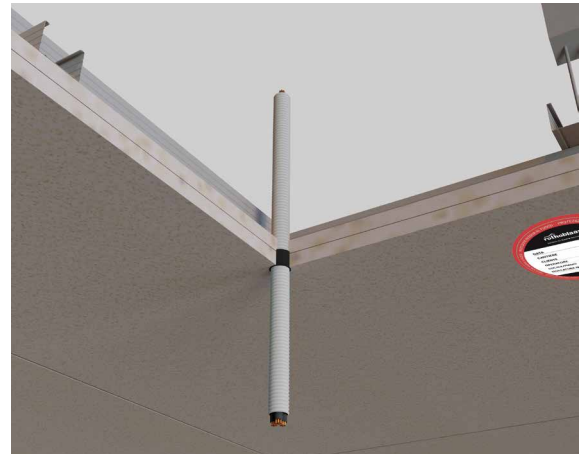
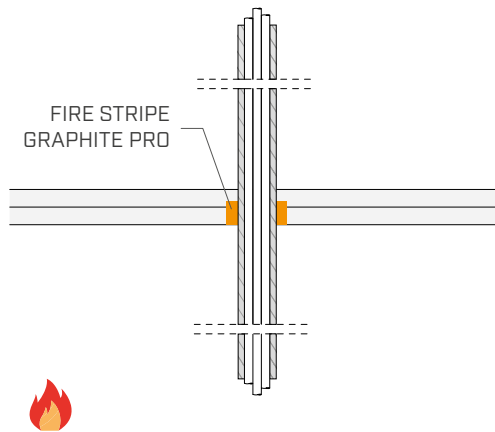

PENETRATION

TYPES	Electrical cables in combustible pipes
PIPE DIAMETER	≤ 21 mm
PIPE INSULATION	≤ 40 mm
HOLE DIMENSION	Equal to the pipe diameter

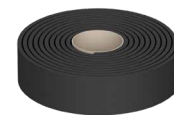

FIRE STRIPE GRAPHITE PRO

PERFORMANCE CRITERIA

FIRE STRIPE GRAPHITE PRO applied only on the side exposed to fire

FALSE CEILING WITH THICKNESS ≥ 50 mm [25 mm thick F-type double plasterboard sheet]

TYPE OF PENETRATION SYSTEM	PIPE DIAMETER	
	[mm]	
corrugated plastic pipe with cable	≤ 21 mm	

Reference standard: EN 1363-1| EN 1366-3

INSTALLATION

- Wrap two layers of FIRE STRIPE GRAPHITE PRO around the pipe
- Fasten FIRE STRIPE GRAPHITE PRO with adhesive tape and position it at the penetration on the fire side.

Rotho Blaas Srl

Via dell'Adige N.2/1 | 39040, Cortaccia (BZ) | Italia
Tel: +39 0471 81 84 00 | Fax: +39 0471 81 84 84
info@rothoblaas.com | www.rothoblaas.com

